

Ergün LAFLI and Gülseren KAN ŞAHİN\*

## TERRA SIGILLATA AND RED-SLIPPED WARE FROM HADRIANOPOLIS IN SOUTHWESTERN PAPHLAGONIA\*\*

In the Roman and Byzantine periods Paphlagonia was an area on the north-central Black Sea coast of Asia Minor, situated between Bithynia and Pontus, and bordered by Galatia by the eastern prolongation of the Bithynian Olympus. Culturally, it was a contact zone between Greeks in the Black Sea area and the indigenous population of the Central Anatolian plateau. The region is the least well-known area with the regard to Hellenistic and Roman ceramics in comparison with other countries that are located on the Black Sea coasts, namely Bulgaria, Romania, Moldova, Ukraine, Russia and Georgia. The few number of Roman pottery studies that have been conducted in the region are not sufficient to draw an accurate picture of the ceramicological heritage there<sup>1</sup>. Some recent field work has provided results about the Hellenistic and Roman ceramic traditions in the region, such as studies at Sinope<sup>2</sup>, Tieion and Pompeiopolis<sup>3</sup>. Excavations and surveys at Aizanoi<sup>4</sup>, Pessinus<sup>5</sup>, Tavium<sup>6</sup>, Amorium<sup>7</sup>, Gordion<sup>8</sup>, Ancyra<sup>9</sup>, Çadır Höyük, and Kerkenes etc. have brought to light some evidence of local production in the Roman Central Anatolia. By the researches elsewhere in the Black Sea we know that the southern Pontic

littoral (i.e. Paphlagonia and its eastern neighbour Pontus) was the major production centre for Pontic sigillata in the Roman times<sup>10</sup>. Transport *amphorae* were produced in Paphlagonian coastal cities, such as Sinope, Heracleia, and Amastris between the 4<sup>th</sup> cent. B.C. and the 5<sup>th</sup> cent. A.D. in large quantities. Amisus was also an influential centre for coroplastic production beginning at the latest in the Hellenistic period. Less well known is the hinterland of Paphlagonia, especially its southwestern part where R. J. Matthews of the British Institute of Archaeology at Ankara directed field surveys between 1997 and 2001, producing some Hellenistic-Roman ceramic evidence.

Hadrianopolis is located 3 km west of the modern town of Eskipazar, near Karabük. Geographically it was on the principal western route from the Central Anatolian Plain through the mountains to Bartın and the Black Sea. Thus it lies basically in Roman southwestern Paphlagonia and on the borderline of the Galatian, Bithynian and Paphlagonian territories (Map 1). It was a small but important site, controlling this major route and dominating a rich agricultural, especially vinicultural, hinterland. It has been deter-

\*) Dokuz Eylül Üniversitesi, Edebiyat Fakültesi, Arkeoloji Bölümü, Tınaztepe/Kaynaklar Yerleşkesi, Buca, TR-35160 İzmir, TURKEY; <elafli@yahoo.ca>; <gulserenkan@hotmail.com>.

\*\*\*) All the plates were drawn by G. Kan Şahin, who also took the photographs with A. Cumalıoğlu (İzmir). Maps are by E. Laflı. In the catalogue section numbers in brackets are indicating find numbers of the field project. Abbreviations in the catalogue: th: thickness; h: height; w: width; d: diameter; max.: maximum. – We would like to thank to following colleagues for their help with various aspects of this paper (alphabetically): William Anderson (Melbourne), Ash Cumalıoğlu (İzmir), Sylvia Fünfschilling (Augst), Chris Lightfoot (New York), John Lund (Copenhagen), Arthur Muller (Lille/Athens), Britta Ramminger (Hamburg), Ole Stilborg (Storefors), Sami Patacı (İstanbul) and Aksel Tibet (İstanbul). For the first pottery report of Hadrianopolis: Laflı/Kan Şahin in print a.

1) An attempt: Laflı 2006.

2) Fırat 2010.

3) Two recent studies on the pottery finds from the excavations at Pompeiopolis: Early Roman fine wares: Zhuravlev 2011; and Late Roman pottery: Domzalski 2011. Both authors recognized numerous 'imported wares' to Pompeiopolis which we did not identify in Hadrianopolis. Thus Roman pottery from Hadrianopolis reflects a very different picture than the fine wares at Pompeiopolis in Paphlagonia.

4) Ateş 2003.

5) Devreker *et al.* 2003.

6) Laflı 2003 and Weber-Hiden 2003.

7) Harrison 1991 and 1992.

8) Henrickson 1992.

9) Very little known about the Roman pottery traditions of Ancyra: Kaya 2005. Ceramic finds from Ulus-Ankara rescue excavations in 1990s are currently being studied by C. Küncü at Gazi University in Ankara.

10) Knipowitsch 1929.

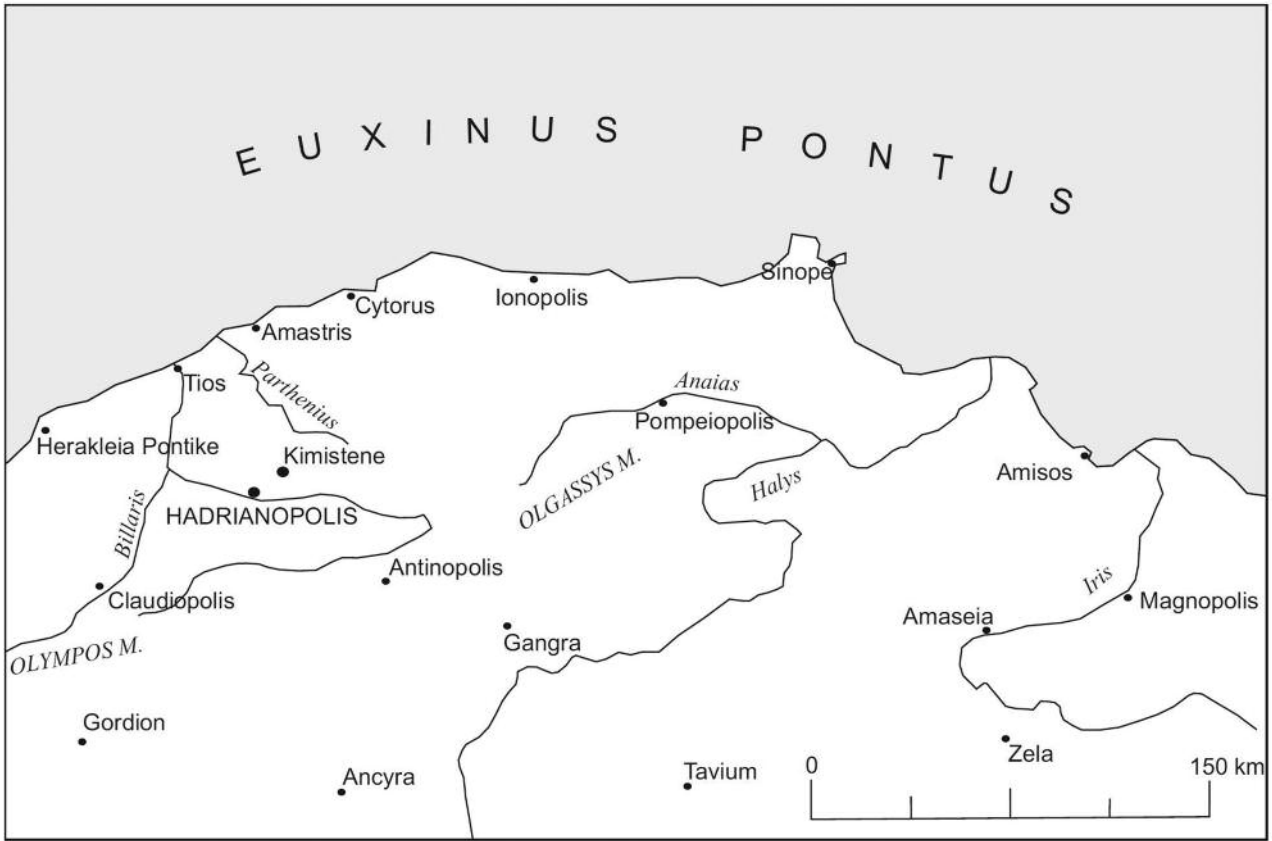

**Map 1 : Map of Paphlagonia.**

mined that the nucleus of the ancient city extended along the Eskipazar-Mengen highway for 8 km east-west and 3 km north-south (Map 2). The *chora* of Hadrianopolis is much more extensive in size. At the site it was difficult to locate a classical settlement pattern of a typical Greco-Roman *polis*, since parts of the city are widely distributed in the area and they are far from each other.

Southwestern Paphlagonia in the Roman period was a densely populated region. There were two major cities in the inland of Paphlagonia: Hadrianopolis and Gangra (modern Çankırı). Hadrianopolis, however, seems to be more intact than Gangra in its southern neighbourhood. It is the only large-sized settlement of inland Paphlagonia that can be excavated. We know that in the 1<sup>st</sup> cent. B.C. there was already a site on the location of Hadrianopolis, called as *Caesareia*. Until the era of Hadrian this site was perhaps the regional capital; after Hadrian its name and probably status were changed. We do not know much about the Hadrianic era in Paphlagonia and its impact on ceramic traditions.

In 2005 archaeological field surveys were begun at Hadrianopolis and its environs by a team from the Dokuz Eylül University, Izmir. As a result of our 2005 surveys it has been confirmed that Hadrianopolis was indeed located at modern Eskipazar, with finds dating from the 1<sup>st</sup> cent. B.C. to the 8<sup>th</sup> cent. A.D. In 2006 and 2007 excavations were carried out, and 2008 was our restoration season on the site. The field activities between 2005 and 2008 identified the remains of at least 25 buildings (Map 3)<sup>11</sup>. Among them are two bath buildings of the Late Roman-Early Byzantine periods, two Early Byzantine churches, a *Domus* (formerly called as “villa”), a fortified structure of the Middle Byzantine period, a possible *theatron*, a vaulted building, a domed building, and some domestic buildings with mosaic floors.

In general, these four campaigns have established that Hadrianopolis was a fortified regional centre during the Late Roman and Early Byzantine periods (5<sup>th</sup>-7<sup>th</sup> cent. A.D.), when it can easily be defined as a “polis” with civic buildings. It had a fairly large

11) On the field season 2006: Laflı and Zöh 2008; season 2007: Laflı and Zöh 2009; season 2008: Laflı 2009a; on the surveys at Kimistene in 2005: Laflı and Christof 2011a; on all of the field seasons: Laflı and Christof 2011b; on Middle/Late Byzantine pottery: Laflı and Kan Şahin 2010; and glass finds: Laflı 2009b.



**Map 2 : Map of surveyed areas in southwestern Paphlagonia in 2005.**

urban population as well as an extensive agrarian rural population in its *chora*. Most of the visible surface remains in southwestern Paphlagonia belong to this period. Roman and earlier remains seem to consist almost exclusively of inscriptions, rock-cut graves, some cultic monuments, and a small amount of pottery (including sigillata), but not civic buildings. It seems that the city was abandoned during the second quarter of the 8<sup>th</sup> cent. A.D.

Discoveries were also made out in the *chora* of Hadrianopolis. An area within a radius of 20 km around Hadrianopolis was extensively surveyed and more than 30 archaeological sites with numerous functions were discovered. These sites were *höyük*s, cemeteries, single graves or grave groups, *tumuli*, stone quarries, farmyards, villages, sanctuaries, and other remains. From these settlements pottery was the most significant find group in dating and characterizing the settlement patterns. In the *chora* of Hadrianopolis the most visible and largest Hellenistic and Roman site is Kimistene whose settlement status is not definable yet.

#### DESCRIPTION OF THE DEPOSITS

The fineware information from Hadrianopolis is derived from the following areas: Bath A, *Domus*, Bath B, Apisidal Building, Western Tomb as well as

field surveys (cf. Table below). Since the excavations have concentrated more on the Early Byzantine period, most of the Late Hellenistic-Roman material was collected from non-stratified contexts that are frequently residual, with a mixture of infills from later periods. In very few excavated areas we have discovered fills dominated by earlier pottery. One example is the Room 9 of Bath A, where a large number of fragmentary sigillata was recovered. Our main criterion for the chronology of deposits was numismatic evidence.

The Bath A was a monumental building located in the southern part of the city, *ca.* 130 m southwest of Early Byzantine Church B, which was excavated in 2003 by the Archaeological Museum of Ereğli. In 2006 and 2007 a great part of the structure was excavated revealing 15 rooms. One can assume that Bath A has five archaeological phases, i.e. A.D. 475-525, 525-575, 575-675, 675-725 and 725 (i.e. Arab invasions to Gangra and to Hadrianopolis) to 19<sup>th</sup> cent. In this latest phase Bath A must have been converted into a barn. It was the most important find spot for ceramics and other small finds (glass, bronzes) in our study. The pottery assemblages from the rubble layers of the Bath A contain a great quantity of sherds of Late Roman-Early Byzantine cooking pots as well as some terra sigillata. The

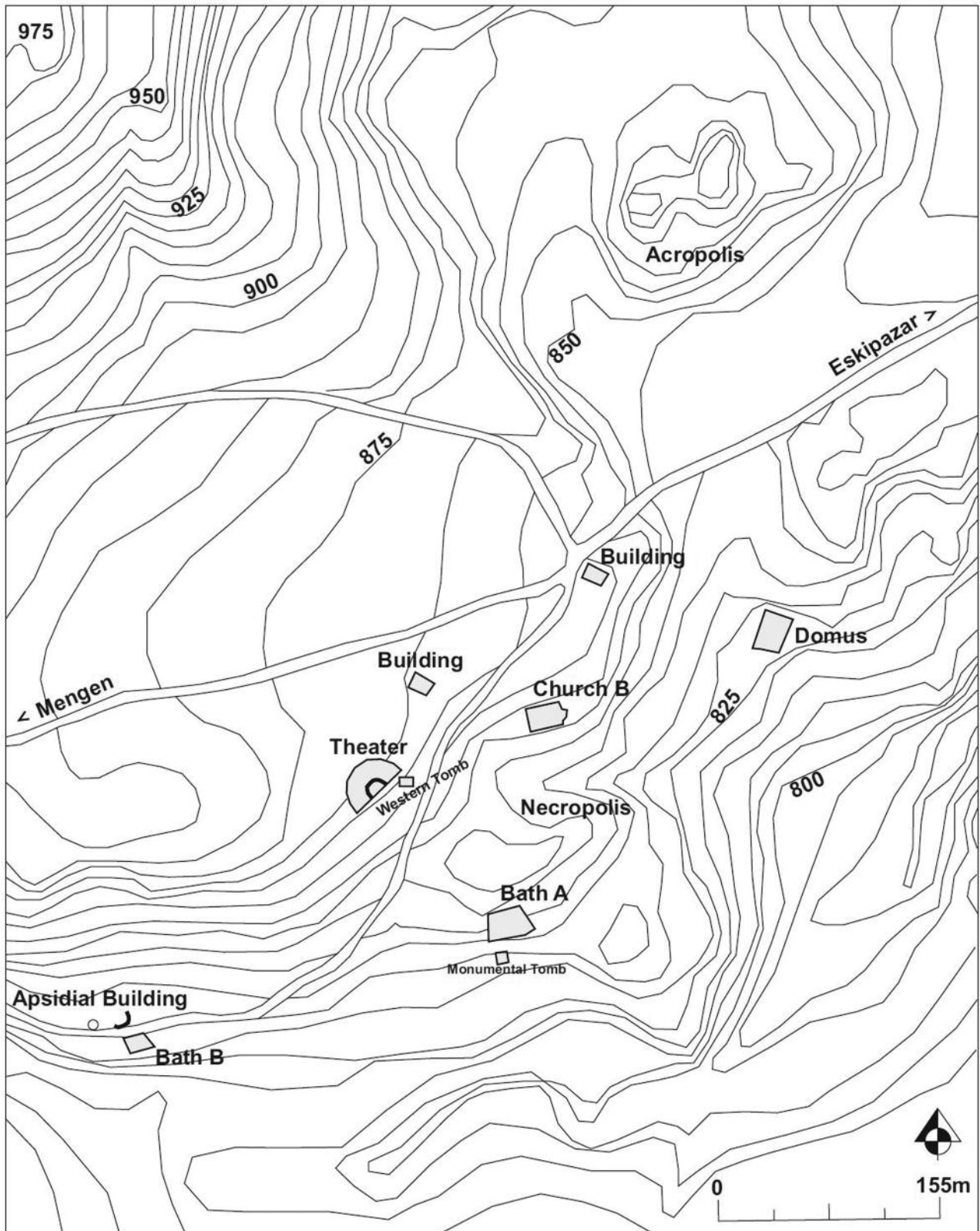

Map 3 : Plan of Hadrianopolis in 2008.

largest assemblage is Late Roman-Early Byzantine coarse ware. The deposit ranges from 1<sup>st</sup> cent. A.D. to 19<sup>th</sup> cent. A.D.; finds after 8<sup>th</sup> cent., however, are very sparse and singular. The assemblages contain very few (almost 10% of whole assemblages) sherds earlier than 5<sup>th</sup> cent. A.D. Almost all the sherds of 1<sup>st</sup> to 5<sup>th</sup> cent. A.D. originate from the construction level of the Bath A. It is very possible that the layers are not well-sealed and that there is some stratigraphical disturbance within them.

The *Domus* provided us with numerous examples of a specific red-slipped bowl form, with or without slip. Based on numismatic evidence this deposit is typically an early 6<sup>th</sup> cent. A.D. deposit, although it contained some earlier and later sherds. It must have been in use until the end of the 7<sup>th</sup> cent. A.D.

Other excavated areas in Hadrianopolis with sigillata finds are as follows: Western and Monumental Tombs (finds from the 1<sup>st</sup> to 3<sup>rd</sup> cent. A.D., with some later sherds); Church B and Apsidal Building (finds from the 6<sup>th</sup> to 8<sup>th</sup> cent. A.D., with some earlier sherds).

In the East of the township of Eskipazar, near the village of Deresemail and the hamlet of Değirmenbaşı there is a ridge called Asartepe with four hilltops, the ancient site of Kimistene, mentioned by Strabo (12.3.41)<sup>12</sup>. On the northern slope of its *Acropolis*, on an artificial terrace, lie the remains of a rural sanctuary of Roman times. All surface remains, retaining walls of the temple terrace, rectangular foundations of the temple and of its *cella* as well as the monumental access staircase leading to the terrace were documented during the 2005 field survey. The stylistic classification of the architectural blocks belonging to the temple reveals at least two phases of the temple construction, one in the late 2<sup>nd</sup>/early 3<sup>rd</sup> cent. A.D., and a second, perhaps only a repair phase, during the 3<sup>rd</sup> cent. A.D. Field surveys at Asartepe covered three further areas or “peaks” along the mountain ridge in addition to the *Acropolis*: Necropolis 1, Necropolis 2, and the Cistern. Most of the material was collected from the *Acropolis*. The site clearly shows occupation over a long period, with particularly important phases in the Hellenistic and Roman periods. Surface pottery ranges from the Late Iron Age into the Middle/Late Byzantine period. Although most of the pottery seems to have been locally produced, there are few imports. The large amount of pottery confirms the importance of the site, already known from architectural, sculptural and epigraphic finds.

A further surveyed area is Göletarkası, a site ca. 3 km east of Hadrianopolis, between Hadrianopolis and Kimistene. This site yielded some Late Roman red-slipped sherds, especially sherds of 4<sup>th</sup>-6<sup>th</sup> cent. A.D.

A further site with earlier sigillata (i.e. 1<sup>st</sup>-2<sup>nd</sup> cent. A.D.) is Boncuklar – a cemetery site –, ca. 10 km southeast of Asartepe. Some inscriptions from the 3<sup>rd</sup> cent. A.D. were found here.

Also to be mentioned is a burial site with rock-cut tombs and a cistern, called Kepez, ca. 12 km southeast of Hadrianopolis where we discovered an homogenous Hellenistic pottery assemblage. Very few Roman pottery was discovered at this site.

**Table : Terra sigillata and red-slipped ware sherds from each place that are represented in the catalogue.**

Bath A	113
Surface Finds from Hadrianopolis	26
Boncuklar	25
<i>Domus</i>	22
Elsewhere at the Acropolis of Kimistene	20
Acropolis of Kimistene, southern slope	25
Acropolis of Kimistene, eastern slope	7
Acropolis of Kimistene, northern slope	3
Acropolis of Kimistene, western slope	2
Necropolis of Kimistene	3
Göletarkası	5
Western Tomb	5
Monumental Tomb	3
Church B	3
Bath B	7
Apsidal Building	1
Kepez	1
Other find spots	2

## POTTERY FINDS

During the four seasons of field research between 2005 and 2008 a wide range of ceramic materials was collected from both field surveys and excavations; a total of ca. 1500 fragments was examined. In this article both survey and excavation finds will be examined together. The pottery finds from Hadrianopolis do not enable us to make assumptions on the population of this landscape.

12) For Kimistene: Lafli and Christof 2011a.

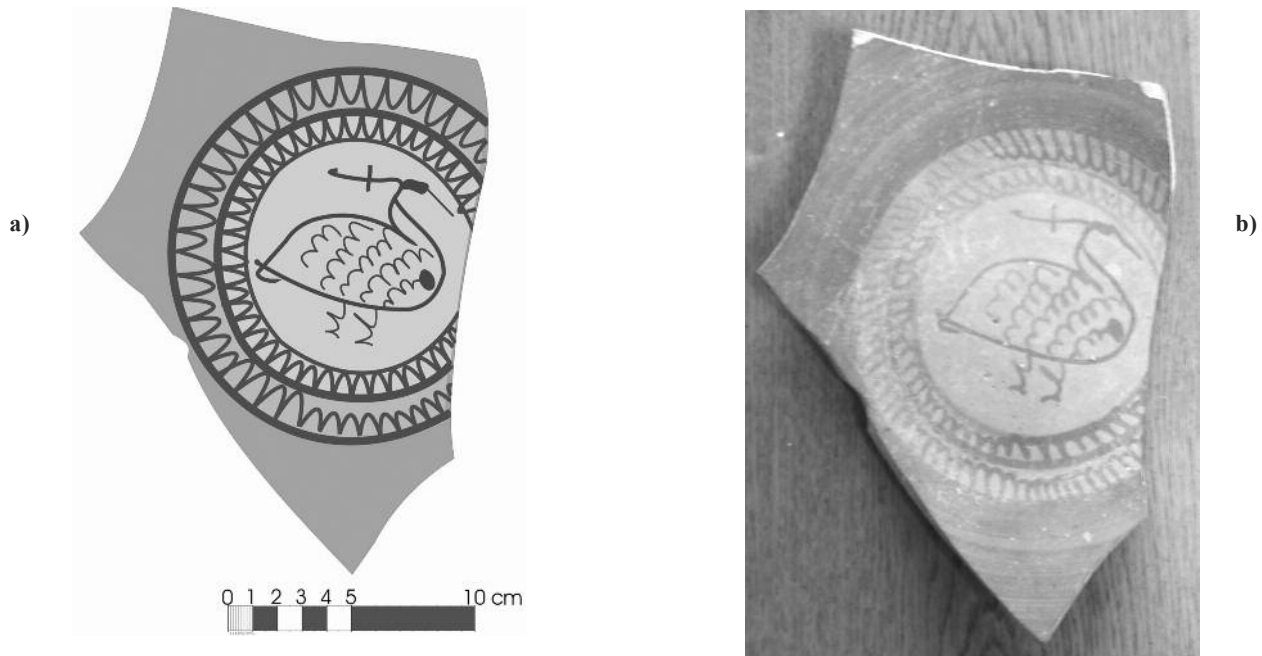

**Fig. 1 a-b : An Early Byzantine painted dish from the *Domus*.**

The main ceramic groups of Hadrianopolis during the Late Hellenistic, Roman, and Late Roman-Early Byzantine periods are fineware, coarse ware (cooking ware, painted kitchen ware, storage vessels etc.), very few transport *amphorae*, oil lamps, *unguentaria*, *pithoi*, miscellaneous terracotta objects, tiles, and bricks as well as water pipes. Generally the surface and stratified collection of local and imported ceramics dating to these periods (1<sup>st</sup> cent. B.C. to early 8<sup>th</sup> cent. A.D.) represent an isolated typology with scanty number of wares and forms with less quality. Through the quantification of the material and examination of clay there is strong evidence to suggest that the great majority of these vessels of all periods were manufactured in southwestern Paphlagonia. Local origin of the material, however, was not proved by mineralogical analysis of the clay.

The majority of the pottery found in Hadrianopolis belongs to Late Roman-Early Byzantine coarse wares that include pottery utilised for domestic storage, all phases of food preparation and service, containers and other functions. Fineware of the period between the 5<sup>th</sup> and 8<sup>th</sup> cent. A.D. is less in number, perhaps because of the consumption of glass vessels. Generally, the forms of the coarse wares from Hadrianopolis tend to be very conservative and restricted to a few certain types. Kitchen pottery,

for instance, is represented by casseroles, pots, frying pans, troughs, basins, pitchers, jugs, juglets and trefoil-jugs with a very limited and slow morphological evolution<sup>13</sup>. A small number of very unique local vessels feature a variety of decorations, such as red-brown to brown painting on the flat tondos of the open shapes (Fig. 1a-b). Very few transport *amphorae*, perhaps of local origin as well, were recorded at Hadrianopolis which is puzzling considering prolific viticulture of the region.

In our pottery study we have put all the sherds earlier than the Roman period into a “Pre-Roman” classification, forming twelve main groups from pre-Iron Age, Iron Age, Hellenistic<sup>14</sup> and Late Hellenistic periods. Definable wares of these four periods are as follows:

- Pre-Iron Age sherds (from the *höyük*s in the area),
- Iron Age grey ware,
- Iron Age painted ware,
- Iron Age coarse ware,
- Pontic black glazed *skyphos* fragment of northern Black Sea origin (4<sup>th</sup> cent. B.C.),
- Hellenistic painted ware,
- Hellenistic relief ware,
- Hellenistic burnished ware,
- Red-painted Kepez group,
- Late Hellenistic-Early Roman grey ware,

13) Such observations were also made in Gordion: Henrickson 1992.

14) On Iron Age and Hellenistic pottery from southwestern Paphlagonia: Laflı and Kan Şahin in print.

– Late Hellenistic-Early Roman brown-slipped ware,

– Hellenistic coarse ware.

Most of these earlier, so-called pre-Roman groups come from Kimistene.

The groups of Roman finewares in southwestern Paphlagonia are as follows:

– Late Hellenistic-Early Roman grey ware,

– Late Hellenistic-Early Roman brown-slipped ware (a local alternating Late Hellenistic group of mostly closed vessels for burials, imitating earlier ‘Greek’ forms),

– Terra sigillata,

– Red-slipped ware,

– Non-slipped fineware,

– Others.

In Hadrianopolis the earliest Roman fineware is represented by grey ware, dating from 1<sup>st</sup> cent. B.C. to the 2<sup>nd</sup> cent. A.D. (i.e., for proto-sigillata phase) which was almost exclusively locally produced, following the Late Iron Age (so-called ‘Phrygian’) tradition in production technics, i.e. manufacture and firing, and clearly also in the development of types<sup>15</sup>. It seems that the Late Hellenistic and pre-Hadriatic periods at Hadrianopolis were characterized by grey ware as well as brown-slipped ware, and there is extremely few sherds in Hadrianopolis earlier than 1<sup>st</sup> cent. B.C. Original ‘Phrygian’ grey ware of Late Iron Age has been found at the nearby settlement of Kimistene, the nature of which is not known in detail. Since Kimistene and other nearby settlements in Hadrianopolis’s *chora* yielded also pottery of the Bronze and Iron Ages, it is surprizing to observe the physical similarity in appearance between Late Hellenistic-Early Roman grey ware in Hadrianopolis and earlier grey wares in its *chora*. Also brown-slipped ware is a close relative of local sigillata in terms of fabric, shapes, slip technics applied, etc.

In our studies, 273 Roman fineware sherds (terra sigillata and red-slipped wares) in total were examined<sup>16</sup>. The number of sigillata sherds in the entire ceramic material from Hadrianopolis is less than 20% of the total. Our study is based on fragmentary pieces, since no intact sigillata vessel was found. No grave pottery has been examined in context yet. Their preservation is mostly fine, perhaps because they were never in use as daily vessels.

## EARLY ROMAN IMPORTED FINEWARES

The inland location of Hadrianopolis in southwestern Paphlagonia means that the quantity of imported pottery is very limited (*ca.* 2% of the whole amount of Roman finewares). These are likely to include Eastern Sigillata A of the 1<sup>st</sup> cent. B.C. (pl. 1, n<sup>os</sup> 1-3) and African red-slipped or Pontic red-slipped of the 3<sup>rd</sup> cent. A.D. (pl. 12, n<sup>o</sup> 227).

ESA is described by J. W. Hayes, P. Kenrick, and K. W. Slane<sup>17</sup>, supporting a source in northern Syria<sup>18</sup>. The colour of the fabric of the Hadrianopolis sherds belongs to the yellower end of the spectrum, with red-brown to red slip, normally associated with pre-Augustan period (1<sup>st</sup> cent. B.C.). Pontic sigillata is also described by Hayes<sup>19</sup>, and only one sherd in southwestern Paphlagonia seems to be of Pontic origin. All five imported sherds were imitated by the local potters.

## LOCAL SIGILLATA AND RED-SLIPPED WARE

At Hadrianopolis there is not a rich variety of pottery of Roman finewares: between the 1<sup>st</sup> cent. B.C. and 2<sup>nd</sup> cent. A.D. we have a terra sigillata tradition, in the 3<sup>rd</sup> and 4<sup>th</sup> cent. A.D. red-slipped ware, and after the 4<sup>th</sup> cent. A.D. red-slipped forms were continued to be produced until the end of the 7<sup>th</sup> cent. A.D., but in unslipped versions. The majority of the local sigillata were represented as very fragmentary sherds, ranging between 1 and 7 cm, in average 2 cm and making them difficult to parallel to the standart corpora. The majority of terra sigillata and red-slipped ware from the Early Roman to the Late Roman periods occur in a single fabric likely to be local or regional in production. Taking into account their form, slip and fabric one can easily assume that the local sigillata from Hadrianopolis can be classified according to the common shapes of Eastern and Pontic sigillata. Where these sigillata were produced or how they came to the city has not yet been explained. The later red-slipped ware in Hadrianopolis was documented to a lesser extent; in the surrounding area of Hadrianopolis this ware emerges more frequently. In Hadrianopolis it seems that coarse wares do occur in greater amounts first in Late Roman period.

15) S. Mitchell believed there was no Hellenistic phase of Hadrianopolis (Mitchell 1993: 93). But we have few Late Hellenistic pottery from Hadrianopolis.

16) These sherds are today in the Museum of Amasra.

17) Hayes 1985: 9-10; Kenrick 1985: fabric 223; Slane 1997: fabric 267-70.

18) Slane 1997: 272.

19) Hayes 1985: 92-96, pls. XXII-XXIII.



**Fig. 2a-c : Fragments of an Early Roman local sigillata juglet found by J. Mellaart in Mengen-Bartın.**

#### **FABRIC OF THE LOCAL SIGILLATA AT HADRIANOPOLIS**

In various aspects the fabric of the Hadrianopolis sigillata is similar to the local sigillata of Ancyra as well as of Tavium, all of which still remain sparsely known by the ceramic surveyors. Local terra sigillata from southwestern Paphlagonia is distinctive and a product of the fast wheel, which has left wheel marks on the surface. The wall thickness of the terra sigillata varies between 0.2 and 0.6 cm and red-slipped ware between 0.5 and 0.9 cm. Generally vessels have simple contours. Red-slipped vessels are, however, consisting of large forms with thickened walls of coarse fabric and tend to have a poor finish.

The firing temperature of Hadrianopolis sigillata is always very high. Their hardness degree at Mohs' chart is '3'. The clay is fine and average quality in character: fine clay with intensive light red (2.5YR

6/8-6/6), reddish yellow (5YR 6/6-7/6) and red (10R 5/6-5/8, 2.5YR 5/8). The rest of the terra sigillata samples are light red (2.5YR 7/6, 10R 6/6-6/8) and red (2.5YR 5/6). They are rarely pink (7.5YR 7/4), red (2.5YR 5/6) and light reddish brown (5YR 6/4). In eight samples there are colour differences because of their uneven firing. As for inclusions, calcite, mica, and sand were applied; grog was rarely used. These inclusions are mostly fine grained and were used together, but in some samples none of them were observed. The average dimension of inclusions is 0.2-0.4 mm. The density of inclusions is average. The clay is well-sieved. In some samples the surface is slightly porous.

Identified slip colours differ according to the typology of vessels and date of the product. Their colour resembles the clay colour. Slipping techniques are mostly the same; it differs only in some sherds. Most popular slip colours on the exterior are red (10R 5/8-4/8-5/6, 2.5YR 5/6-5/8), rarely red (2.5YR 4/6) and light red (2.5YR 6/8). In the interior, red (10R 5/8, 2.5YR 5/8) is the most frequent colour. In the unslipped areas it is light red (2.5YR 7/6) and pink (5YR 7/4, 7.5YR 7/4). In open vessels the slip was applied more elaborately. More often the slip was spaced out erratically, and the slip of interior and exterior sides differs from each other. In most cases sigillata has a look of bichrome painting and contains less metallic sheen. In some cases exterior surface was slipped only in limited areas, in rim parts or in the middle part of the vessel. Exterior surface of bases in both open and closed vessels were left unslipped. In some cases only rim parts were slipped. In later red-slipped wares the slip is mostly washed out and calcified.

#### **FORMS**

Few forms were produced, all of which belong to the most common ones in the Roman Mediterranean. The forms are influenced by many of the giant fineware industries throughout the Mediterranean and the Black Sea. In the absence of kiln finds or secure provenience for the terra sigillata found at Hadrianopolis as well as of parallels from nearby sites, it is unwise to define our fabrics or to date them too closely. There is almost no unusual shapes.

The forms of the terra sigillata are grouped first into 'open' and 'closed' categories, whereas open and simple forms are more common than the closed and complicated ones (more than 60% of the shapes are open). The main forms of terra sigillata from Hadrianopolis are cups, bowls, dishes, plates and juglets. Large dishes and plates were not frequently consumed in Hadrianopolis. It seems that sigillata

from Hadrianopolis concentrated on thin-walled and shapes smaller than 20 cm, probably because they were perceived as alternatives to contemporary glass and metal vessels whereas we have very few Early Roman glass finds. No deep bowls or wide forms, such as containers, were discovered. Some of the forms (cups, bowls and juglets) are most common in Hadrianopolis and they reflect a 'Paphlagonian-Bithynian' character in their style. Some local pre-Roman forms continued to exist into the Roman times in sigillata form. The survival of bowls with simple incurved rim characteristic of the Hellenistic period in a red-slipped form is astonishing and could be classified as a further evidence for the survival of pre-Roman pottery manufacture tradition during the Roman era.

It is difficult to reconstruct the whole body form only through the rim sherds. Also base, handle and body fragments are difficult to assign to any existing forms, but at least we were able to classify them according to 'open' and 'closed' shapes, and most likely handles should be associated with jugs, since it seems to be the main closed shape among the sigillata.

### DECORATION

The finds are mostly without any stamped or painted decoration except for their exterior slip. Stamped decoration is only found on 2% of the whole assemblage. The most common decoration on the sigillata are impressed geometric designs. These are flutings, ripples, notches, stamps, bands, dotted lines, combed, punctuated or rouletted decorations, circles and other motives arranged horizontally, vertically, centered or in panels. The occasional decorated rim ledge associated with African red-slipped ware on round or rectangular bowls and dishes were also collected. In contrast to Ancyra none of these local vessels bears potters stamps.

### CHRONOLOGY

The chronology of southwestern Paphlagonian terra sigillata is problematic since we can only deal with very fragmentary material with weak stratification. It seems reasonable to assume that the sigillata at Hadrianopolis is concentrated in the 1<sup>st</sup> and 2<sup>nd</sup> cent. A.D. Cups and bowls should have been used as grave gifts of the 1<sup>st</sup> cent. A.D.<sup>20</sup>. After the 3<sup>rd</sup> cent. A.D. the local red-slipped tradition began, continuing until the early 6<sup>th</sup> cent. A.D.

Sigillata from Hadrianopolis is evidence of a local red-slipped ware industry in southwestern Paphlagonia, northwestern Galatia, and eastern Bithynia. Evidence for manufacturing sites, manufactures, kiln sites or kiln wasters in or outside our study area, however, has not yet been discovered. Nor have overfired fineware been found so far. All of the sigillata is made of similar local clay, but it has not yet been possible to perform laboratory analyses of the composition. The peak of this quality ware of Roman type seems to fall in the 1<sup>st</sup> cent. A.D., a period characterised by important historical changes on the north-central Anatolian plateau and among the population of the region. Production of smooth and shiny surfaced sigillata continued without any break until the 3<sup>rd</sup> cent. A.D., although later pieces (4<sup>th</sup> and 5<sup>th</sup> cent.) do not have the same shiny slip, and therefore should be attributed rather to 'red-slipped ware'. Examples of this type of local sigillata are also known to the authors as unprovenienced examples in local museums in North-Central Turkey (Museums of Çankırı, Kastamonu, Amasra and Ereğli). In particular, Roman pottery collections at the Museum of Çankırı derive mostly from burials in this region (Fig. 3a-b).

We would like to construe the model of local production and distribution of sigillata from Hadrianopolis as 'self production and consumption in a limited area'. Limited and isolated typologies and lack of evidence of import ware are further indications in favour of this type of local economy model. Because of the long distance to the coastline and commercially poor situation, this area reflects a reserved and closed economic system in Roman Asia Minor.

Through these local products one has the impression that in a relatively short period of time (from the 1<sup>st</sup> cent. B.C.) the Roman tableware industry in Paphlagonia developed parallels to other manufactures in Western and Southern Asia Minor. Perhaps the presence of a large population in South-Western Paphlagonia at the beginning of the 1<sup>st</sup> cent. A.D. from various parts of the Roman Empire resulted in an active form of ceramic industry. Through archaeological finds one can suppose that shortly after the establishment of Roman political presence in the region, the inhabitants of Roman Paphlagonia began to use sigillata at least for their burials and abandoned their former tradition of Phrygian grey ware at the latest in the 2<sup>nd</sup> cent. A.D.

20) For instance, a juglet with three fragments at the British Institute of Archaeology at Ankara, collected by J. Mellaart from Mengen-Bartın in Southwestern Paphlagonia (Fig. 2a-c).



a)



b)

**Fig. 3a-b : Roman sigillata bowls at the Museum of Çankırı; Fig. 3a : Inv. n° 145-9.4.72; Fig. 3b : Inv. n° 236-73.4.2.**

### FORM CATALOGUE

#### TERRA SIGILLATA (pls. 1-11)

##### IMPORTED SHERDS (pl. 1)

Only four sherds were recorded: three rim fragments as well as a body sherd that probably belongs to one of the rim sherds. All of these fragments originate from Kimistene. Very few imported sherds were found at Hadrianopolis. Thus one can question the role of Kimistene in terms of imported material. Perhaps its religious status had an impact on the materials' routes. All of these sherds are ESA products, and not Pontic. Thus one can assume that Late Hellenistic Southwestern Paphlagonia had relationships with the South.

#### ESA BOWL=HAYES 2008, FORM 51 (pl. 1/n° 3)

Half of a globular body with an incurved rim was recorded. On the interior a mottled slip. Pink fabric. This fragment was found in Kimistene, Acropolis. Similar bowls were typologically classified by Hayes into two groups. At Benghazi similar shapes have a diameter ranging between 9.8 and 13.5 cm. Our sample has a dia. of 13.4 cm. Dated by Hayes to A.D. 70-120<sup>21</sup>; a close date is given by Kenrick, based on the finds from Benghazi<sup>22</sup>.

##### pl. 1/3 and pl. 23/4.

1. (N° 956): Rim fragment; Kimistene, Acropolis, found in 2005.

Max. h 2.9 cm, d of rim 13.4 cm, max. w 2.5 cm, max. th 0.5 cm.

Red (2.5YR 5/8) slip on the exterior, red (2.5YR 5/8) and reddish brown (2.5YR 5/8) mottled slip on the

interior, hard, thin paste, non-porous, fine, pink (7.5YR 7/4) fabric with no visible inclusions.

Devreker *et al.* 2003: 229, Fig. 123, n° 1 and Kenrick 1985: 239, Fig. 43, 337.1.  
C. 70-120 A.D.

#### ESA BOWL=HAYES 2008, FORM 12 (pl. 1/n° 1)

One example was found in the field surveys at Hadrianopolis. Part of small bowl with short flat and everted rim. Curving body is narrow. Exterior slip mottled. Pink fabric.

In Tel Anafa most of the pieces have a narrow horizontal rim and are found in ROM 1B stratum<sup>23</sup>. Similar fragments at Benghazi were found in the levels of the middle Augustan period and dated to the early 1<sup>st</sup> cent. B.C.<sup>24</sup>. Hayes dated them from 50 B.C. to the beginning of 1<sup>st</sup> cent. A.D.<sup>25</sup>.

##### pl. 1/1 and pl. 23/1.

2. (N° 983): Rim fragment; from the field surveys in Hadrianopolis, found in 2005.

Max. h 1.7 cm, max. w 2.4 cm, max. th 0.5 cm.

Red (2.5YR 4/6) and dark reddish brown (2.5YR 3/4) mottled slip on exterior, reddish brown (2.5 YR 4/4) slip on interior, hard, thin paste, non-porous, fine, pink (7.5YR 7/4) fabric with with no visible inclusions.

Slane 1997: 303, TA Type 19, pl. 15, FW 154.  
1<sup>st</sup> cent. B.C.

#### ESA DISH, HAYES 2008, FORM 4 (pl. 1/n° 2)

Two dish fragments belong to Hayes Form 4. The rims are convex. In this form rosettes, rulet and

21) Hayes 1985: 37, form 50, pl. VI, n°s 19-20.

22) Kenrick 1985: 239, fig. 43, 337.1.

23) Slane 1997: 303.

24) Kenrick 1985: 418-419.

25) Hayes 1985: 19, form 12, pl. II, n° 10 and 2008: 25.

palmets are very common on their tondos. Their slip is red in colour and non-porous. Fine clay with very few inclusions.

Hayes identified them as 'small plate' and dated them to the 1<sup>st</sup> cent. B.C.<sup>26</sup>.

**pl. 1/2 and pl. 23/2.**

3. (N° 683): Rim fragment; Kimistene Acropolis, eastern slope, found in 2005.

Max. h 4.2 cm, max. w 5.9 cm, max. th 1.2 cm.

Red (2.5YR 5/8) slip on exterior and interior, hard, thin paste, non-porous, change of colour on fabric, light red (2.5YR 6/8) and reddish yellow (7.5YR 7/6) fabric with some lime and grog inclusions.

Hayes 2008: 24, form 4, pl. 2, n° 32 and Meyer-Schlichtmann 1988: 90, Taf. 11, 98.N2.

1<sup>st</sup> cent. B.C.

**pl. 23/3.**

4. (N° 489): Body fragment; Kimistene Acropolis, southern slope, just below the summit, up to Dereemail creek, found in 2005.

Max. h 3.2 cm, max. w 2.9 cm, max. th 1.2 cm.

Red (2.5YR 5/8) slip on exterior and interior, hard, thin paste, non-porous, fine light red (2.5YR 6/8) fabric with lime inclusions.

**LOCAL PRODUCTS-OPEN FORMS**

(pls. 2-8)

As mentioned above, this group consists of a cup, bowls and dishes. There are furthermore some body and base fragments which we list here so that these groups will be comprehended to a greater extend.

**CUP (pl. 2)**

Only one fragment belongs to this cup form: a thin-walled cup with everted rim of a possibly half globular shape in the manner of the brown slip tradition of Late Hellenistic period. Shiny brown-reddish slip from the rim to the middle of the exterior body. The rest of the body is left unslipped.

At Tel Anafa, some smaller samples were dated to the first quarter of the 1<sup>st</sup> cent. B.C.<sup>27</sup>.

**pls. 2 and 24.**

5. (N° 208): Rim fragment; Bath A, Room 1, found in 2006.

Max. h 3.9 cm, d of rim 10.2 cm, max. w 5.5 cm, max. th 0.3 cm.

Red (10R 5/6) and weak red (10R 4/2) mottled slip on exterior rim, its below part reddish yellow (5YR 7/6) unslipped surface, light red (2.5YR 6/6) slip on interior rim, its lower part pink (5YR 8/4) surface, thin paste, non-porous, fine, reddish yellow (5YR 7/6) fabric with no visible inclusions.

Slane 1997: 300, TA Type 15, pl. 14, FW 142.

Around 50 B.C.

**BOWLS (pls. 3-5)**

**BOWL FORM 1 (pl. 3)**

Nine fragments belong to this group. This form (especially n°s 7 and 10-12) is actually a derivation of the most common hemispherical Hellenistic cup form<sup>28</sup>, as well as of the ESA form 25 in Tel Anafa<sup>29</sup>. It is interesting to find its original ESA shape with local imitations in Southwestern Paphlagonia. N° 14 has a concave profile with an incurved rim. Usually it has a simple rim and ring base. Its low wall curves gently and continuously to end in a plain, upright rim flattened on the top. In intact forms its base is thickened on the outside. Similar shapes at Pergamon were dated into the mid 1<sup>st</sup> cent. B.C. and beginning of the 2<sup>nd</sup> cent. A.D.<sup>30</sup>. This form is also present at Pompeiopolis<sup>31</sup>.

The colour ranges between reddish brown and red. The non-porous slip ranges between reddish brown and red. Diameters are from 13 to 17.6 cm.

**pl. 3/6 and pl. 25/6.**

6. (N° 302): Rim fragment; Bath A, Room 2b, found in 2006.

Max. h 1.1 cm, max w 2.6 cm, max. th 0.2 cm.

Reddish brown (5YR 4/4) slip on exterior, reddish brown (5YR 4/3) slip on interior, non-porous, hard, thin paste, fine, dark reddish gray (5YR 4/2) fabric with no visible inclusions.

**pl. 3/7 and pl. 25/7.**

7. (N° 299): Rim fragment; Bath A, Room 2b, found in 2006.

Max. h 1.6 cm, w 2.9 cm, max. th 0.4 cm.

Red (10R 5/8) slip on exterior and interior, thin paste, non-porous, hard, fine, light red (2.5YR 6/8) fabric with no visible inclusions.

Meyer-Schlichtmann 1988: 135, Taf. 17, 265.T4.

Middle of the 1<sup>st</sup> cent. B.C. to early 2<sup>nd</sup> cent. A.D.

26) Hayes 1985: 16, form 4A, pl. I, n° 9 and 2008: 24, form 4, fig. 2, n° 32.

27) Slane 1997: 299.

28) Gunneweg *et al.* 1983: 96, fig. 21.4.

29) Slane 1997: 309, pl. 18, FW 190.

30) Meyer-Schlichtmann 1988: 135, pl. 17: 266.T4.

31) Zhuravlev 2011: 12, fig. 2, 5-7; dated to 2<sup>nd</sup> and 3<sup>rd</sup> cent. A.D.

**pl. 3/8 and pl. 25/8.**

8. (N° 296): Rim fragment (part of a bowl); Bath A, Room 2b, found in 2006.

Max. h 2.9 cm, max. w 2.1 cm, max. th 0.4 cm.

Light red (2.5 YR 6/8) and red (2.5 YR 5/8) mottled slip on exterior, red (10R 5/8) slip on interior, thin paste, non-porous, average hardness, change of colour on fabric, red (2.5YR 5/8) and reddish yellow (5YR 6/8) fabric with infrequent sand and micaceous inclusions.

Slane 1997: 312, Type 25 a, pl. 18, FW 192.

1<sup>st</sup> cent. B.C., probably pre-30 B.C.

**pl. 3/9 and pl. 25/9.**

9. (N° 957): Rim fragment; Kimistene Acropolis, found in 2005.

Max. h 2.0 cm, max. w 1.7 cm, max. th 0.3 cm.

Red (2.5YR 5/8) slip on exterior and interior, non-porous, average hardness, thin paste, fine, light red (2.5YR 6/6) fabric with some lime inclusions.

**pl. 3/10 and pl. 25/10.**

10. (N° 982): Rim fragment; from the field surveys in Hadrianopolis, found in 2005.

Max. h 2.7 cm, max. w 2.1 cm; max. th 0.4 cm.

Shiny red (2.5YR 5/8) slip on exterior and interior, non-porous, average hardness, thin paste, fine, red (10R 5/6) fabric with no visible inclusions.

**pl. 3/11 and pl. 25/11.**

11. (N° 563): Rim fragment; surface find from the village Boncuklar, found in 2005.

Max. h 1.6 cm, max. w 1.8 cm, max. th 0.4 cm.

Thin, shiny red (2.5YR 5/8) slip on exterior and interior, non-porous, average hardness, thin paste, fine, red (2.5YR 5/8) fabric with some micaceous inclusions.

Devreker *et al.* 2003: 233, fig. 124, n° 3.

Early Roman.

**pl. 3/12 and pl. 25/12.**

12. (N° 580): Rim fragment; Kimistene Acropolis, southern slope, just below the summit, up to Deresemal creek, found in 2005.

Max. h 1.6 cm, max. w 2.3 cm, max. th 0.5 cm.

Light red (2.5YR 6/8) slip on exterior and interior, non-porous, average hardness, thin paste, fine, red (2.5YR 5/8) fabric with some lime inclusions.

**pl. 3/13 and pl. 25/13.**

13. (N° 310): Rim fragment; Bath A, Room 2b, found in 2006.

Max. h 1.5 cm, d of rim 13.0 cm, max. w 3.1 cm, max. th 0.4 cm.

Red (10R 5/8) slip on exterior and interior, very sparsely porous, hard, fine, red (10R 5/8) fabric with some lime and very little micaceous inclusions.

Devreker *et al.* 2003: 233, fig. 124, n° 2 (ESA).

Early Roman.

32) Hayes 2008: 30, fig. 7, n°s 180 and 184.

**pl. 3/14 and pl. 25/14.**

14. (N° 235): Rim fragment; Bath A, Room 9, surface find, found in 2006.

Max. h 1.6 cm, d of rim 17.6 cm, max. w 3.7 cm, max. th 0.5 cm.

Shiny yellowish red (5YR 5/6) slip on exterior, shiny reddish brown (2.5YR 5/4) on interior, hard, non-porous, fine, light reddish brown (2.5YR 7/3) fabric with infrequent tiny micaceous inclusions.

Slane 1997: 290, TA type 13 variant c, pl. 8, FW 77, 79.

**BOWL FORM 2 (pls. 4-5)**

This bowl form is also an imitation of ESA Samaria Form 10. N°s 15, 16, 18, 22, 25 and 31 have a flat or beaded rim and curving wall. N°s 25 and 31 have more vertical wall different from the others. N°s 15 and 25 have a beaded rim, and n°s 17 and 21 have an everted rim. N°s 19, 20, 23, 27, and 30 have a round or globular body form with inward sloping mostly S-profiled wall and thin rim. The curving wall ends in a thickened rim flattened on the top. This is actually a former form which was used in Central Anatolia since the Phrygians. It seems to be very popular in Early Roman southwestern Paphlagonia. Among later samples from the Athenian Agora there is a similar one, identified by Hayes<sup>32</sup>.

Their rim diameters differ between 11.2 and 26.4 cm. The ware colour is light reddish brown and light brown.

**pl. 4/15 and pl. 26/15.**

15. (N° 896): Rim fragment; Kimistene Acropolis, southern slope, underground cave, surface find, found in 2005.

Max. h 1.3 cm, max. w 2.5 cm, max. th 0.5 cm.

Red (2.5YR 4/8) slip on exterior, red (10R 5/8) slip on interior, non-porous, thin paste, hard, fine, red (10R 5/6) fabric with some lime inclusions.

**pl. 4/16 and pl. 26/16.**

16. (N° 1135): Rim fragment; Kimistene Acropolis, found in 2005.

Max. h 1.6 cm, max. w 2.5 cm, max. th 0.4 cm.

Red (10R 5/8) slip on exterior, weak red (10R 5/3) and red (10R 5/8) mottled slip on interior, average hardness, non-porous, fine, light red (10R 6/6) fabric with occasional micaceous and rare sand inclusions.

**pl. 4/17 and pl. 26/17.**

17. (N° 579): Rim fragment; from the field surveys in Hadrianopolis, found in 2005.

Max. h 2.1 cm, max. w 2.0 cm, max. th 0.4 cm.

Red (2.5YR 4/6) slip on exterior, red (2.5YR 5/6) slip on interior, average hardness, non-porous, fine light reddish brown (5YR 6/4) fabric with some lime inclusions.

Devreker *et al.* 2003: 213, fig. 113, n° 2

Early Roman.

**pl. 4/18 and pl. 26/18.**

**18.** (N° 306): Rim fragment; Bath A, Room 2b, found in 2006.

Max. h 1.8 cm, max. w 2.6 cm, max. th 0.3 cm.

Matt red (2.5YR 5/8) slip on exterior, red (2.5YR 5/8) slip on interior, very sparsely porous, thin paste, hard, fine, red (2.5YR 5/8) fabric with no visible inclusions.

Williams 1989: 12, fig. 4, n° 59.

1<sup>st</sup> cent. B.C. to early 1<sup>st</sup> cent. A.D.<sup>33</sup>.

**pl. 4/19 and pl. 26/19.**

**19.** (N° 183): Rim fragment; Bath A, Room 6c, an area close to the floor, found in 2006.

Max. h 2.4 cm, max. w 5.5 cm, max. th 0.5 cm.

Shiny reddish brown (5YR 5/4) mottled slip on exterior, reddish brown (5YR 5/3) slip on interior, hard, fine, light reddish brown (2.5YR 6/3) fabric with no visible inclusions.

Similar to Hayes 2008: 140, fig. 7, n° 184 and Williams 1989: 12, group A3, fig. 4, n° 58.

Around A.D. 200.

**pl. 4/20 and pl. 26/20.**

**20.** (N° 269): Rim fragment; Bath A, Room 3, illegal excavation pit, found in 2006.

Max. h 1.6 cm, d of rim 20.6 cm, max. w 3.6 cm, max. th 0.4 cm.

Light red (2.5YR 6/8) slip on exterior, thin, matt red (10R 5/8) slip on interior, non-porous, hard, thin paste, fine, light red (10R 6/6) fabric with infrequent lime inclusions.

Same references as n° 19.

Around A.D. 200.

**pl. 4/21 and pl. 26/21.**

**21.** (N° 320): Rim fragment; Bath A, Room 2b, found in 2006.

Max. h 2.1 cm, d of rim 11.2 cm, max. w 3.0 cm, max. th 0.5 cm.

Reddish brown (5YR 4/4) and dark reddish brown (5YR 3/3) matt, mottled slip on exterior, matt red (2.5YR 4/8) slip on interior, sparsely porous, average hardness, fine, pink (7.5YR 7/4) fabric with frequent sand inclusions.

**pl. 4/22 and pl. 26/22.**

**22.** (N° 837): Rim fragment; Kimistene, Cistern, found in 2005.

Max. h 2.2 cm, d of rim 11.6 cm, max. w 2.6 cm, max. th 0.3 cm.

Red (10R 5/8) slip on exterior and interior, hard, thin paste, non-porous, fine, light red (10R 6/8) fabric with infrequent lime and sand inclusions.

Meyer-Schlichtmann 1988: 117, Taf. 14, 198, Sa 3.

Middle of the 1<sup>st</sup> cent. to first half of the 2<sup>nd</sup> cent. A.D.<sup>34</sup>.

**pl. 4/23 and pl. 26/23.**

**23.** (N° 181): Half of the bowl; Bath A, Room 6a-c, close to the floor, found in 2006.

Max. h 3.2 cm, d of rim 12.6 cm, max. w 6.4 cm, max. th 0.3 cm.

Yellowish red (5YR 5/6) and reddish brown (5YR 5/4) mottled slip on exterior, weak red (10R 5/4) slip on interior, smoothed surface, hard, very sparsely porous, fine, very pale brown (10YR 7/4) fabric with some micaeous inclusions.

Possibly imported?

Around A.D. 200.

**pl. 4/24 and pl. 26/24.**

**24.** (N° 406): Rim fragment; Kimistene Acropolis, eastern slope, the lower temple terrace, close to the creek, found in 2005.

Max. h 2.6 cm, d of rim 13.4 cm, max. w 5.9 cm, max. th 0.4 cm.

Thin red (2.5YR 5/8) slip on exterior, metallic, shiny weak red (2.5YR 4/2) slip on interior rim, its below part red (2.5YR 5/6) slip, hard, non-porous, thin paste, fine, light red (2.5YR 6/8) fabric with infrequent lime inclusions.

**pl. 4/25 and pl. 26/25.**

**25.** (N° 1487): Rim fragment; surface find from the village Boncuklar, found in 2005.

Max. h 1.5 cm, d of rim 13.4 cm, max. w 3.1 cm, max. th 0.4 cm.

Brown (7.5YR 5/4) slip on exterior and interior, average hardness, non-porous, thin paste, fine, reddish yellow (5YR 7/6) fabric with some sand inclusions.

Williams 1989, 11, fig. 4, n° 56.

1<sup>st</sup> cent. B.C. to early 1<sup>st</sup> cent. A.D.<sup>35</sup>.

**pl. 5/26 and pl. 27/26.**

**26.** (N° 277): Rim fragment; Bath A, Room 14, found in 2006.

Max. h 3.1 cm, d of rim 14.6 cm, max. w 3.6 cm, max. th 0.3 cm.

Reddish yellow (5YR 7/8) and light red (2.5 YR 6/6) mottled slip on exterior, shiny light red (2.5YR 7/6) and pale red (10R 6/4) mottled slip on interior, hard, thin paste, fine, reddish yellow (5YR 7/6) fabric with infrequent tiny sand inclusions.

33) Williams 1989: 9.

34) Meyer-Schlichtmann 1988: 117.

35) Williams 1989: 9.

**pl. 5/27 and pl. 27/27.**

**27.** (N° 1421): Rim fragment; Church B, found in 2005.

Max. h 3.5 cm, d of rim 18.4 cm, max. w 5.2 cm, max. th 0.6 cm.

Red (10R 5/8) slip on exterior and interior, plain surface, soft, thin paste, non-porous, fine, red (10R 5/8) fabric with no visible inclusions.

**pl. 5/28 and pl. 27/28.**

**28.** (N° 184): Rim fragment, Bath A, Room 6a-c, an area close to the floor, found in 2006.

Max. h 1.8 cm, d of rim 18.6 cm, max. w 5.4 cm, max. th 0.5 cm.

Matt reddish yellow (5YR 6/6) slip on exterior, yellowish red (5YR 5/6) slip on interior, smoothed surface, thin paste, sparsely porous, hard, fine, light brown (7.5YR 6/4) fabric with infrequent lime inclusions.

**pl. 5/29 and pl. 27/29.**

**29.** (N° 267): Rim fragment; Bath A, Room 3, illegal excavation pit, found in 2006.

Max. h 1.9 cm, d of rim 18.8 cm, max. w 4.6 cm, max. th 0.4 cm.

Shiny red (2.5YR 5/8) slip on exterior, shiny red (10R 5/8) slip on interior, very sparsely porous, hard, fine, light red (2.5YR 7/6) fabric with rare sand inclusions.

Around A.D. 200.

**pl. 5/30 and pl. 27/30.**

**30.** (N° 305): Nearly upper half of the bowl; Bath A, Room 2b, found in 2006.

With three grooves on its exterior surface. Short triangular plain surface, at topped rim.

Max. h 2.8 cm, d of rim 20.0 cm, max. w 6.1 cm, max. th 0.4 cm.

Shiny red (2.5YR 5/8) and red (10R 5/8) slip on exterior, red (10R 5/8) matt slip on interior, thin paste, hard, change of colour on fabric, light red (2.5YR 6/8) and light red (2.5YR 7/8) fabric with occasional sand inclusions.

Around A.D. 200.

**pl. 5/31 and pl. 27/31.**

**31.** (N° 432): Rim fragment; from the field surveys in Hadrianopolis, found in 2006.

Max. h 1.6 cm, d of rim 26.0 cm, max. w 3.9 cm, max. th 0.5 cm.

Red (2.5YR 4/8) slip on exterior, red (2.5YR 5/8) slip on interior, smoothed surface, thin paste, non-porous, hard, fine, red (2.5YR 5/8) fabric with no visible inclusions.

Possibly imported?

Meyer-Schlichtmann 1988: 128, Taf. 16, 235.Sa27a. 1<sup>st</sup>/2<sup>nd</sup> cent. A.D.

**pl. 5/32 and pl. 27/32.**

**32.** (N° 195): Rim fragment, Bath A, Room 5, found in 2006.

Max. h 2.0 cm, d of rim 26.4 cm, max. w 4.1 cm max. th 0.5 cm.

Red (10R 5/8) slip on exterior, red (10R 5/8) and light red (2.5YR 6/8) mottled slip on interior, very sparsely porous, average hardness, fine, light red (2.5YR 6/6) fabric with some tiny sand inclusions.

**DISHES (pl. 6)****DISH FORM 1 (pl. 6/n<sup>os</sup> 33-36)**

A shallow dish with everted rim. The most distinctive typological feature of this dish form is its angled and raised rim. *Ca.* 2 or 3 cm below the rim there is a further angle which gives the wall as S-profile. Thus, this form resembles to Hayes 1985: 29, form 34, pl. V, n° 7. Their diameters differ between 16.6 and 17.4 cm.

Early Italian sigillata forms are dated to the beginning of the 1<sup>st</sup> cent. A.D. and later Italian series are dated by Hayes to A.D. 70-150<sup>36</sup>. Similar forms from Belbek IV Necropolis in the southwestern Crimea were identified by Zhuravlev as 'Pontic sigillata' and dated to the last quarter of the 1<sup>st</sup> or the beginning of the 2<sup>nd</sup> cent. A.D.<sup>37</sup>.

**pl. 6/33 and pl. 28/33.**

**33.** (N° 197): Rim fragment; Bath A, Room 5, on the floor, found in 2006.

Max. h 2.8 cm, max. w 3.4 cm, max. th 0.5 cm.

Red (10R 4/6) slip on exterior, red (10R 5/8) slip on interior, hard, very sparsely porous, thin paste, fine, red (7.5R 5/6) fabric with no visible inclusions.

Zhuravlev 2009: 36, fig. 4, form 2.2, n° 25.

Last quarter of the 1<sup>st</sup> or the beginning of the 2<sup>nd</sup> cent. A.D.<sup>38</sup>.

**pl. 6/34 and pl. 28/35.**

**34.** (N° 226): Rim fragment, Bath A, Room 13, found in 2006.

Max. h 3.1 cm, d of rim 16.6 cm, max. w 3.8 cm, max. th 0.5 cm.

Reddish brown (2.5YR 5/4) slip on upper exterior, its below part pink (7.5YR 7/4) unslipped surface, brown (7.5YR 5/4) slip on interior, thin paste, hard, fine, light brown (7.5YR 6/3) fabric with some micaceous inclusions.

Zhuravlev 2009: 36, fig. 4, form 2.2, n° 31. Rim is similar to Ettlinger *et al.* 1990: 100, pl. 25.

36) Hayes 2008: 41.

37) Zhuravlev 2009: 36, fig. 4, form 2.2, n° 25.

38) Zhuravlev 2009: 36.

**pl. 6/35 and pl. 28/34.**

**35.** (N° 1387): Rim fragment; surface find from Göletarkası (a possible cemetery site), found in 2005.

Max. h 2.8 cm, d of rim 17.2 cm, max. w 4.7 cm, max. th 0.5 cm.

Thin, matt red (10R 5/6) slip on exterior, red (10R 5/8) slip on interior, thin paste, non-porous, hard, fine, red (10 R 5/8) fabric with infrequent sand inclusions.

Zhuravlev 2009: 36, fig. 4, form 2.2, n° 30.

**pl. 6/36 and pl. 28/36.**

**36.** (N° 219): Rim fragment, Bath A, Room 13, found in 2006.

Max. h 2.8 cm, d of rim 17.4 cm, max. w 4.7 cm, max. th 0.5 cm.

Red (10R 4/8) slip on upper exterior, its below part red (10R 5/8) slip, brown (7.5YR 5/4) slip on interior, thin paste, non-porous, hard, fine, pink (5YR 7/4) fabric with no visible inclusions.

References same as n° 34.

**DISH FORM 2** (pl. 6/n<sup>os</sup> 37-41)

A dish with a wide, everted and decorated rim. Smaller as well as larger forms are represented. The decoration – even on the outcurved rim – consists of dots, waves etc. The ware contains lime and sand inclusions.

**pl. 6/37 and pl. 28/37.**

**37.** (N° 298): Rim fragment; Bath A, Room 2b, found in 2006.

Max. h 1.6 cm, d of rim 29.0 cm, max. w 6.8 cm, max. th 0.4 cm.

Red (10R 4/8) and red (10R 5/8) mottled slip on exterior, shiny red (10R 4/8) slip on interior, smoothed surface, hard, thin paste, non-porous, fine, light red (10R 6/6) fabric with infrequent sand inclusions.

1<sup>st</sup> cent. B.C.

**pl. 6/38 and pl. 28/38.**

**38.** (N° 947): Rim fragment; Kimistene Acropolis, found in 2005.

Max. h 0.8 cm, max. w 1.9 cm, max. th 0.6 cm.

Red (10R 5/8) slip on interior and exterior, sparsely porous, average hardness, fine, red (10R 5/6) fabric with some sand and occasional lime inclusions.

**pl. 6/39 and pl. 28/39.**

**39.** (N° 307): Rim fragment; Bath A, Room 2b, found in 2006.

Max. h 2.1 cm, max. w 1.4 cm, max. th 0.6 cm.

Red (10R 5/8) slip on exterior and interior, non-porous, thin paste, hard, fine, red (10R 5/8) fabric with rare lime inclusions.

**pl. 28/40.**

**40.** (N° 507): Rim fragment; from the field surveys in Hadrianopolis, found in 2005.

Max. h 1.8 cm, max. w 1.9 cm, max. th 0.5 cm.

Matt red (10R 5/6) slip on exterior and interior, hard, non-porous, fine, reddish brown (5YR 5/4) fabric with some lime inclusions.

**pl. 28/41.**

**41.** (N° 221): Rim fragment; Bath A, Room 13, found in 2006.

Max. h 2.3 cm, max. w 1.9 cm, max. th 0.4 cm.

Red (10R 5/8) slip on exterior and interior, hard, non-porous, thin paste, fine, red (10R 5/8) fabric with occasional lime inclusions.

**DISH FORM 3** (pl. 28/n° 42)

This is represented only by one single sherd with a 3 cm wide and 1 cm thick distinctively everted rim and a sharply descending wall. Mottled surface in the interior. Light red fabric with some tiny sand inclusions. It was found in Bath A, Room 2b.

**pl. 28/42.**

**42.** (N° 290): Rim fragment, Bath A, Room 2b, found in 2006.

Max. h 4.5 cm, max. w 4.2 cm, max. th 0.8 cm.

Red (10R 5/8) slip on exterior, red (10R 5/8) and light red (2.5YR 6/8) mottled slip on interior, thin paste, non-porous, hard, fine, light red (2.5YR 6/8) fabric with some tiny sand inclusions.

**DISH FORM 4** (pl. 6/n° 43)

Dish form 4 is also represented by a single sherd. It has everted and bowed rim, and a shallow body form with a gently descending wall. Its form is similar to that of the Hellenistic fish plate. The outside of the rim has a mottled black slip decoration. The rest of the body surface is red. Its fabric is light red in colour. Its diameter is 28.8 cm. It was found in Bath A, Room 5.

Zhuravlev dates this form to the 1<sup>st</sup>-3<sup>rd</sup> cent. A.D.<sup>39</sup>.

**pl. 6/43 and pl. 28/43.**

**43.** (N° 193): Fragment of a shallow dish with everted rim, Bath A, Room 5, found in 2006.

Max. h 1.7 cm, d of rim 28.8 cm, max. w 5.7 cm, max. th 0.6 cm.

Red (10R 5/8) slip on exterior, red (10R 5/8) slip on interior and dusky red (10R 3/3) slip bant on interior rim, average hardness, thin paste, fine, light red (2.5YR 7/6) fabric with some micaceous and lime inclusions.

Zhuravlev 2002: 256, fig. 12, n° 4.

39) Zhuravlev 2002: 256.

**PLATE** (pl. 7)

Three fragments belong to a plate form with a flat base on a ring foot<sup>40</sup>. Its surface is smoothed. The slip is red in colour all over the surface except for the foot which remained unslipped. A light reddish brown line in the middle may result from bad firing or secondary firing. These fragments were found in Bath A. The diameter should be *ca.* 20.0 cm.

On its tondo is a medallion with some further decoration patterns consisting of seven recognizable letters in form a monogram, and in the middle part a cross and three boxes. In the frame of the medallion there are two more letters.

Transcription:

In the frame:  
[—]HΘ[—]

Sherd c (tondo):  
[—]  
AKΔΔYLOY  
Ψ Three boxes E

**pls. 7 and 29.**

**44.** (N° 274a-c): Base fragment, Bath A, Room 14, found in 2007.

Three fragments: fragments a-b: max. h 2.7 cm, d of base 20.0 cm, max. w 10.4 cm, max. th 0.9 cm; fragment c: max. h 5.8 cm, max. w 7.6 cm; max. th 0.7 cm.

Red (2.5YR 5/8) slip on exterior, pink (5YR 7/4) unslipped surface on foot, red (2.5YR 5/8) and red (10R 5/8) mottled slip on interior, hard, fine, light reddish brown (5YR 6/4) fabric with some sand inclusions.

Kenrick 1985: 394, fig. 74, type B, n° 702.4/6.

**BASE FRAGMENTS OF OPEN FORMS** (pl. 8)

Four fragments belong to open forms. Some base fragments cannot be assigned to any known forms besides obviously belonging to open forms (dishes or bowls?). They are important in reflecting the range of colours applied at the local sigillata of Hadrianopolis. They have a tiny slip on their exterior and interior surfaces, but the foot is unslipped. The fabric colour varies from red to reddish yellow. The base diameter ranges from 4.6 to 10.0 cm. One fragment was found in Kimistene, the others were found at the Baths A and B.

**pl. 8/45 and pl. 30/45.**

**45.** (N° 78): Base fragment; Bath B, Room 3, illegal excavation pit, found in 2007.

Max. h 1.6 cm, d of base 4.6 cm, max. w 4.5 cm, max. th 0.5 cm.

Light red (2.5YR 6/6) slip on exterior, light red (2.5YR 7/6) unslipped surface on foot, red (2.5YR 4/8) slip on interior, thin paste, non-porous, hard, fine, reddish yellow (5YR 6/6) fabric with some tiny sand inclusions.

**pl. 8/46 and pl. 30/46.**

**46.** (N° 1268): Base fragment; Kimistene, Necropolis I, found in 2005.

Max. h 1.2 cm, d of base 6.2 cm, max. w 6.0 cm, max. th 0.3 cm.

Pink (5YR 7/4) unslipped surface on exterior, red (10R 5/8) slip on interior, thin paste, hard, non-porous, fine, reddish yellow (5YR 7/6) fabric with rare sand inclusions.

**pl. 8/47 and pl. 30/47.**

**47.** (N° 220): Base fragment; Bath A, Room 13, found in 2006.

Body on low ring foot<sup>41</sup>, flat base.

Max. h 0.9 cm, d of base 10.0 cm, max. w 3.9 cm, max. th 0.4 cm.

Red (10R 5/8) slip on exterior and interior, average hardness, non-porous, thin paste, fine, red (10R 5/8) fabric with no visible inclusions.

**pl. 30/48.**

**48.** (N° 292): Base fragment; Bath A, Room 2b, found in 2006.

Max. h 2.1 cm, max. w 3.3 cm, max. th 0.5 cm.

Red (10R 5/8) unslipped surface on exterior, shiny red (10R 5/8) slip on interior, thin paste, non-porous, hard, fine, red (10R 5/8) fabric with no visible inclusions.

**BODY FRAGMENTS OF OPEN FORMS** (pls. 31-32)

None of the 76 fragments can give us any clue to their forms. The fabric colour varies between reddish brown and red.

**pl. 31/49.**

**49.** (N° 314): Body fragment; Bath A, Room 2b, found in 2005.

Max. h 2.3 cm, max. w 3.8 cm, max. th 0.3 cm.

Red (2.5YR 5/6) slip and pink (7.5YR 7/4) unslipped surface on exterior, reddish brown (2.5YR 4/4) slip on interior, hard, fine, pink (7.5YR 7/4) fabric with some lime and infrequent sand inclusions.

40) Williams 1989: 13, fig. 5, n° 64.

41) Robinson 1959: 54, pl. 61, n° J28.

**pl. 31/50.**

**50.** (N° 575): Body fragment; from the field surveys in Hadrianopolis, found in 2005.

Max. h 1.5 cm, max. w 1.7 cm, max. th 0.3 cm.

Red (2.5YR 5/8) and reddish brown (2.5YR 4/4) mottled slip on exterior, reddish brown (2.5YR 4/4) slip on interior, hard, non-porous, thin paste, fine, reddish yellow (5YR 6/6) fabric with some micaceous inclusions.

**pl. 31/51.**

**51.** (N° 595): Body fragment; Kimistene Acropolis, southern slope, just below the summit, up to Dereemail creek, found in 2005.

Max. h 0.9 cm, max. w 1.5 cm, max. th 0.2 cm.

Reddish brown (2.5YR 4/4) and red (10R 5/8) thin slip on exterior, reddish brown (2.5 YR 4/3) slip on interior, sparsely porous, average hardness, fine, reddish yellow (5YR 6/6) fabric with infrequent lime inclusions.

**pl. 31/52.**

**52.** (N° 908): Body fragment; Kimistene Acropolis, southern slope, underground cave, surface find, found in 2005.

Max. h 1.3 cm, max. w 1.4 cm, max. th 0.3 cm.

Thin, weak red (10R 4/4) slip on exterior, smoothed surface on exterior, red (10R 4/6) slip on interior, hard, non-porous, thin paste, fine light red (2.5YR 7/6) fabric with no visible inclusions.

**pl. 31/53.**

**53.** (N° 647): Body fragment; Kimistene Acropolis, western slope, found in 2005.

Max. h 2.5 cm, max. w 3.0 cm, max. th 0.5 cm.

Red (2.5YR 5/6) and dark reddish brown (5YR 3/2) mottled slip on exterior, red (2.5YR 5/6) slip on interior, hard, non-porous, thin paste, fired, to red (2.5YR 5/6) fabric with some micaceous inclusions.

**pl. 31/54.**

**54.** (N° 1140): Body fragment; Kimistene Acropolis, found in 2005.

Max. h 2,0 cm, max. w 2,2 cm, max. th 0.3 cm.

Red (2.5YR 5/8) slip on exterior, weak red (10R 4/4) slip on interior, average hardness, non-porous, thin paste, fine, light red (2.5YR 6/6) fabric with no visible inclusions.

**pl. 31/55.**

**55.** (N° 474): Body fragment; Bath A, Room 2b, found in 2006.

Max. h 1.3 cm, max. w 2.5 cm, max. th 0.3 cm.

Light red (2.5YR 6/8) and red (2.5YR 5/6) slip on exterior, light reddish brown (2.5YR 6/4) slip on interior, very sparsely porous, hard, thin paste, fine, reddish yellow (5YR 7/6) fabric with some sand inclusions.

**pl. 31/56.**

**56.** (N° 1133): Body fragment; Kimistene Acropolis, found in 2005.

Max. h 2.3 cm, max. w 2,0 cm, max. th 0.4 cm.

Red (10R 5/8) slip on exterior, red (10R 5/6) and reddish brown (2.5YR 4/3) mottled slip on interior,

average hardness, non-porous, thin paste, fired to light red (2.5YR 6/8) fabric with no visible inclusions.

**pl. 31/57.**

**57.** (N° 564): Body fragment; surface find from the village Boncuklar, found in 2005.

Max. h 1.6 cm, max. w 1.9 cm, max. th 0.3 cm.

Light red (2.5YR 5/6) and reddish brown (5YR 4/3) slip on exterior, light red (2.5YR 6/6) slip on interior, non-porous, thin paste, hard, fine, reddish yellow (5YR 6/6) fabric with no visible inclusions.

**pl. 31/58.**

**58.** (N° 212): Body fragment; Bath A, Room 1, found in 2006.

Max. h 1.9 cm, max. w 1.7 cm, max. th 0.5 cm.

Red (2.5YR 4/6) slip on exterior, weak red (10R 5/4) slip interior, non-porous, thin paste, hard, change of colour on fabric, pink (7.5YR 7/4) and light reddish brown (2.5YR 7/4) fabric with no visible inclusions.

**pl. 31/59.**

**59.** (N° 510): Body fragment; Kimistene Acropolis, southern slope, just below the summit, up to Dereemail creek, found in 2005.

Max. h 3.1 cm, max. w 4.3 cm, max. th 0.4 cm.

Red (10R 5/8) slip on exterior and interior, non-porous, thin paste, hard, fine, red (2.5YR 5/8) fabric with some lime inclusions.

**pl. 31/60.**

**60.** (N° 1485): Body fragment; *Domus*, found in 2007.

Max. h 2.0 cm, max. w 2.7 cm, max. th 0.4 cm.

Light red (2.5YR 7/6) unslipped surface on exterior, red (2.5YR 5/8) and dark reddish brown (2.5YR 3/3) mottled slip on interior, non-porous, thin paste, hard, fine, reddish yellow (5YR 6/6) fabric with no visible inclusions.

**pl. 31/61.**

**61.** (N° 960): Body fragment; Kimistene Acropolis, found in 2005.

Max. h 1.4 cm, max. w 1.8 cm, max. th 0.3 cm.

Red (2.5YR 5/6) slip on exterior, shiny reddish brown (2.5YR 4/3) slip on interior, sparsely porous, thin paste, hard, fine, light reddish brown (5YR 6/4) fabric with infrequent sand inclusions.

**pl. 31/62.**

**62.** (N° 900): Body fragment; Kimistene Acropolis, southern slope, underground cave, found in 2005.

Max. h 2.0 cm, max. w 1.8 cm, max. th 0.3 cm.

Red (2.5YR 5/6) and dark reddish gray (2.5YR 3/1) mottled slip on exterior, red (2.5YR 5/6) slip on interior, thin paste, non-porous, hard, fine, light red (2.5YR 6/8) fabric with some lime inclusions.

**pl. 31/63.**

**63.** (N° 311): Body fragment, Bath A, Room 2b, found in 2006.

Max. h 2.7 cm, max. w 4.4 cm, max. th 0.6 cm.

Metallic shiny weak red (10R 4/4) and red (2.5YR 5/8) mottled slip on exterior, its below part reddish yellow (5YR 7/6) unslipped surface on exterior, red (10R 5/8) and red (10R 4/8) mottled slip on interior, hard, very sparsely porous, change of colour on fabric, light red (2.5YR 6/6) and reddish yellow (5YR 7/6) fabric with some tiny sand inclusions.

**pl. 31/64.**

**64.** (N° 204): Body fragment; Bath A, Room 13a, found in 2006.

Max. h 2.5 cm, max. w 2.8 cm, max. th 0.4 cm.

Pink (2.5YR 7/4) unslipped surface and red (2.5YR 5/8) slip on exterior, shiny red (10R 5/8) slip on interior, hard, very sparsely porous, fine, pale red (10R 7/4) fabric with occasional lime inclusions.

**pl. 31/65.**

**65.** (N° 1302): Body fragment; Kimistene Acropolis, found in 2005.

Max. h 1.7 cm, max. w 1.5 cm, max. th 0.3 cm.

Reddish brown (5YR 5/4) and yellowish red (5YR 5/6) mottled slip on exterior, red (2.5YR 5/8) slip on interior, thin paste, hard, non-porous, fired to reddish yellow (5YR 7/6) fabric with no visible inclusions.

**pl. 31/66.**

**66.** (N° 856): Body fragment; Kimistene Acropolis, northwestern slope of the temple, found in 2005.

Max. h 2.2 cm, max. w 2.5 cm, max. th 0.4 cm.

Weak red (2.5YR 4/2) slip on exterior, red (2.5YR 5/6) slip on interior, hard, thin paste, very sparsely porous, fired to reddish yellow (5YR 6/6) fabric with infrequent micaceous inclusions.

**pl. 31/67.**

**67.** (N° 534): Body fragment; Bath A, Room 2b, found in 2006.

Max. h 1.6 cm, max. w 1.8 cm, max. th 0.4 cm.

Red (2.5YR 5/8) slip on exterior, red (2.5YR 5/6) slip on interior, thin paste, hard, non-porous, fine, red (2.5YR 5/6) fabric with infrequent lime inclusions.

**pl. 31/68.**

**68.** (N° 962): Body fragment; Kimistene Acropolis, found in 2005.

Max. h 1.2 cm., max. w 2.1 cm, max. th 0.4 cm.

Red (2.5YR 5/8) and reddish brown (2.5YR 4/3) mottled slip on exterior, light red (2.5YR 6/8) slip on interior, average hardness, non-porous, thin paste, fine, reddish yellow (5YR 7/6) fabric with no visible inclusions.

**pl. 31/69.**

**69.** (N° 1424): Body fragment; Church B, found in 2005.

Max. h 2.7 cm, max. w 2.3 cm, max. th 0.4 cm.

Reddish brown (5YR 5/4) slip on exterior, reddish brown (2.5YR 5/4) slip on interior, hard, non-porous,

thin paste, fine, light brown (7.5YR 6/4) fabric with no visible inclusions.

**pl. 31/70.**

**70.** (N° 213): Body fragment; Bath A, Room 1, found in 2006.

Max. h 1.4 cm, max. w 1.4 cm, max. th 0.6 cm.

Reddish brown (2.5YR 5/4) slip on exterior, light red (2.5YR 6/6) slip on interior, non-porous, thin paste, hard, fine, pink (7.5YR 7/4) fabric with frequent sand inclusions.

**pl. 31/71.**

**71.** (N° 557): Body fragment; surface find from the village Boncuklar, found in 2005.

Max. h 1.9 cm, max. w 2.8 cm, max. th 0.6 cm.

Reddish brown (2.5YR 4/4) slip on exterior, reddish brown (2.5YR 5/4) slip on interior, hard, non-porous, thin paste, fired to reddish brown (2.5YR 5/3) fabric with no visible inclusions.

**pl. 31/72.**

**72.** (N° 236): Body fragment; Bath A, Room 9, found in 2006.

Max. h 2.3 cm, max. w 3.1 cm, max. th 0.4 cm.

Reddish brown (5YR 5/4) mottled slip on exterior, shiny weak red (2.5YR 4/2) slip on interior, shiny slip all of surface, non-porous, thin paste, hard, fine, reddish yellow (5YR 7/6) fabric with infrequent micaceous inclusions.

**pl. 31/73.**

**73.** (N° 506): Body fragment; from the field surveys in Hadrianopolis, found in 2006.

Max. h 2.4 cm, max. w 3.3 cm, max. th 0.3 cm.

Red (2.5YR 5/6) unslipped surface on exterior, red (2.5YR 4/6) slip on interior, non-porous, thin paste, hard, fine, red (2.5YR 5/6) fabric with some sand and micaceous inclusions.

**pl. 31/74.**

**74.** (N° 472): Body fragment; Bath A, Room 2b, found in 2006.

Max. h 1.6 cm, max. w 2.8 cm, max. th 0.2 cm.

Red (2.5YR 4/8) slip on exterior, red (10R 5/6) unslipped surface on interior, non-porous, thin paste, hard, fine, red (10R 5/6) fabric with no visible inclusions.

**pl. 31/75.**

**75.** (N° 317): Body fragment; Bath A, Room 2b, found in 2006.

Max. h 2.5 cm, max. w 3.0 cm, max. th 0.3 cm.

Red (10R 5/6) slip on exterior, red (10R 5/8) slip on interior, non-porous, thin paste, hard, fine, light red (10R 6/6) fabric with no visible inclusions.

**pl. 31/76.**

**76.** (N° 1301): Body fragment; Kimistene Acropolis, found in 2005.

Max. h 1.4 cm, max. w 1.2 cm, max. th 0.3 cm.

Shiny red (2.5YR 5/8) slip on exterior and interior, smooth surface, non-porous, thin paste, hard, fine, reddish yellow (5YR 7/6) fabric with some tiny sand inclusions.

**pl. 31/77.**

77. (N° 1145): Body fragment; Kimistene Acropolis, found in 2005.

Max. h 1.7 cm, max. w 1.6 cm, max. th 0.2 cm.

Red (2.5YR 6/8) unslipped surface on exterior, red (2.5YR 5/8) slip on interior, non-porous, thin paste, hard, fine, red (2.5YR 5/8) fabric with no visible inclusions.

**pl. 31/78.**

78. (N° 505): Body fragment; from the field surveys in Hadrianopolis, found in 2005.

Max. h 1.7 cm, max. w 1.8 cm, max. th 0.5 cm.

Red (2.5YR 4/8) slip on exterior and interior, smoothed surface, non-porous, thin paste, hard, fine, red (2.5YR 5/6) fabric with some lime inclusions.

Its edges were rounded, possibly because of its later use as a game token.

**pl. 31/79.**

79. (N° 316): Body fragment; Bath A, Room 2b, found in 2006.

Max. h 2.5 cm, max. w 4.1 cm, max. th 0.5 cm.

Thin red (10R 5/8) slip on exterior and interior, shiny and smoothed surface on interior, non-porous, thin paste, hard, fine, red (10R 5/8) fabric with occasional lime and very little micaceous inclusions.

Possibly belonging to n° 48.

**pl. 31/80.**

80. (N° 1460): Body fragment.

Max. h 3.4 cm, max. w 2.3 cm, max. th 0.4 cm.

Red (10R 5/8) and red (10R 4/8) mottled slip on exterior, shiny red (10R 5/8) slip on interior, non-porous, thin paste, hard, fine, red (2.5YR 4/8) fabric with rare sand inclusions.

**pl. 31/81.**

81. (N° 1390): Body fragment; surface find from Göletarkası, found in 2005.

Max. h 2.0 cm, max. w 2.4 cm, max. th 0.4 cm.

Red (2.5YR 5/8) unslipped surface on exterior, red (2.5YR 4/8) slip on interior, average hardness, non-porous, thin paste, fine, red (10R 5/8) fabric with no visible inclusions.

**pl. 31/82.**

82. (N° 190): Body fragment; Bath A, Room 4, found in 2006.

Max. h 1.9 cm, max. w 2.7 cm, max. th 0.5 cm.

Shiny red (2.5YR 4/8) slip on exterior and interior, non-porous, thin paste, hard, fine, red (10R 5/6) fabric with some sand inclusions.

**pl. 31/83.**

83. (N° 533): Body fragment; Bath A, Room 2b, found in 2006.

Max. h 2.1 cm, max. w 3.7 cm, max. th 0.3 cm.

Red (10R 5/8) and light red (2.5YR 6/8) mottled slip on exterior, red (10R 5/8) slip on interior, non-porous, thin paste, hard, fine, light red (2.5YR 6/8) fabric with no visible inclusions.

**pl. 31/84.**

84. (N° 907): Body fragment; Kimistene Acropolis, southern slope, underground cave, found in 2005.

Max. h 1.7 cm, max. w 1.0 cm, max. th 0.3 cm.

Red (10R 5/8) slip on exterior and interior, smoothed and shiny slip on exterior, hard, non-porous, thin paste, fine, red (10R 5/6) fabric with no visible inclusions.

**pl. 31/85.**

85. (N° 695): Body fragment; Kimistene Acropolis, eastern slope, Cistern, found in 2005.

Max. h 0.9 cm, max. w 1.5 cm, max. th 0.3 cm.

Red (10R 5/8) slip on exterior, red (2.5YR 4/8) slip on interior, thin paste, non-porous, hard, fine, red (10R 5/8) fabric with infrequent sand inclusions.

**pl. 31/86.**

86. (N° 430): Body fragment; from the field surveys in Hadrianopolis, found in 2006.

Max. h 3.0 cm, max. w 3.3 cm, max. th 0.3 cm.

Red (2.5YR 4/8) slip on exterior, red (2.5YR 5/8) slip on interior, hard, non-porous, thin paste, fine, red (10R 5/6) fabric with no visible inclusions.

**pl. 31/87.**

87. (N° 313): Body fragment; Bath A, Room 2b, found in 2006.

Max. h 3.2 cm, max. w 2.9 cm, max. th 0.3 cm.

Matt red (10R 5/8) slip on exterior and interior, thin paste, non-porous, hard, fine, red (10R 5/8) fabric with infrequent lime inclusions.

**pl. 32/88.**

88. (N° 418): Body fragment; from the field surveys in Hadrianopolis, found in 2005.

Max. h 2.6 cm, max. w 2.5 cm, max. th 0.4 cm.

Red (10R 5/8) slip on exterior and interior, thin paste, non-porous, change of colour on fabric, light red (2.5YR 7/6) and reddish yellow (5YR 7/6) fabric with some lime inclusions.

**pl. 32/89.**

89. (N° 270): Body fragment; Bath A, Room 3, illegal excavation pit, found in 2006.

Max. h 2.4 cm, max. w 1.7 cm, max. th 0.5 cm.

Red (10R 5/8) slip on exterior and interior, hard, non-porous, fine, light red (10R 6/6) fabric with no visible inclusions.

**pl. 32/90.**

**90.** (N° 540): Body fragment; Bath A, Room 2b, found in 2006.

Max. h 2.1 cm, max. w 2.2 cm, max. th 0.4 cm.

Thin, matt red (10R 5/8) slip on exterior, shiny red (10R 5/8) slip on interior, hard, non-porous, fine, light red (2.5YR 6/6) fabric with some sand and lime inclusions.

**pl. 32/91.**

**91.** (N° 526): Body fragment; Bath A, Room 2b, found in 2006.

Max. h 1.3 cm, max. w 2.8 cm, max. th 0.4 cm.

Red (10R 5/8) abrasion slip on exterior, red (10R 5/6) slip on interior, hard, thin paste, non-porous, fine, light red (2.5YR 6/6) fabric with some sand and lime inclusions.

**pl. 32/92.**

**92.** (N° 536): Body fragment; Bath A, Room 2b, found in 2006.

Max. h 1.6 cm, max. w 2.3 cm, max. th 0.5 cm.

Red (10R 5/8) slip on exterior and interior, hard, thin paste, fine, red (2.5YR 5/8) fabric with some sand and occasional lime inclusions.

**pl. 32/93.**

**93.** (N° 1481): Body fragment; Monumental Tomb; found in 2007.

Max. h 2.7 cm, max. w 2.6 cm, max. th 0.3 cm.

Red (10R 5/8) slip on exterior and interior, smoothed and shiny surface on interior, hard, thin paste, non-porous, fine, red (10R 5/6) fabric with infrequent sand inclusions.

**pl. 32/94.**

**94.** (N° 904): Body (+base) fragment; Kimistene Acropolis, southern slope, underground cave, found in 2005.

Max. h 1.9 cm, max. w 1.4 cm, max. th 0.6 cm.

Red (10R 5/6) unslipped surface on exterior, red (10R 5/8) slip on interior, shiny and smoothed slip on interior, hard, thin paste, non-porous, fine, red (10R 5/8) fabric with infrequent tiny lime inclusions.

**pl. 32/95.**

**95.** (N° 1439): Body fragment; Church B, found in 2005.

Max. h 1.4 cm, max. w 1.7 cm, max. th 0.3 cm.

Light red (2.5YR 6/8) unslipped surface on exterior, red (10R 5/8) slip on interior, hard, thin paste, very sparsely porous, fine, red (2.5YR 5/8) fabric with no visible inclusions.

**pl. 32/96.**

**96.** (N° 542): Body fragment; Bath A, Room 2b, found in 2006.

Max. h 1.5 cm, max. w 2.4 cm, max. th 0.5 cm.

Red (10R 5/8) slip on exterior and interior, average hardness, thin paste, non-porous, fine, red (10R 5/6) fabric with very little micaceous inclusions.

**pl. 32/97.**

**97.** (N° 1427): Body fragment; Church B, found in 2005.

Max. h 1.0 cm, max. w 1.5 cm, max. th 0.4 cm.

Red (10R 5/8) slip on exterior and interior, hard, thin paste, non-porous, fine, red (10R 5/8) fabric with no visible inclusions.

**pl. 32/98.**

**98.** (N° 1426): Body fragment; Church B, found in 2005.

Max. h 1.9 cm, max. w 1.6 cm, max. th 0.4 cm.

Red (2.5YR 5/8) slip on exterior and interior, shiny slip on interior, hard, thin paste, non-porous, fine, red (10R 5/6) fabric with no visible inclusions.

**pl. 32/99.**

**99.** (N° 1143): Body fragment; Kimistene Acropolis, found in 2005.

Max. h 1.4 cm, max. w 0.8 cm, max. th 0.3 cm.

Red (10R 5/8) slip on exterior and interior, average hardness, thin paste, very sparsely porous, fine, red (10R 5/8) fabric with very little micaceous inclusions.

**pl. 32/100.**

**100.** (N° 577): Body fragment; from the field surveys in Hadrianopolis, found in 2005.

Max. h 1.4 cm, max. w 2.0 cm, max. th 0.3 cm.

Red (2.5YR 5/8) slip on exterior, red (2.5YR 4/8) slip on interior, porous, hard, thin paste, fine, red (2.5YR 5/6) fabric with no visible inclusions.

**pl. 32/101.**

**101.** (N° 431): Body fragment; from the field surveys in Hadrianopolis, found in 2005.

Max. h 1.9 cm, max. w 1.3 cm, max. th 0.4 cm.

Light red (2.5YR 6/8) slip on exterior, red (2.5YR 5/8) slip on interior, porous, hard, thin paste, fine, light red (2.5YR 6/6) fabric with frequent lime inclusions.

**pl. 32/102.**

**102.** (N° 858): Body fragment; Kimistene Acropolis, northwestern slope, found in 2005.

Max. h 1.4 cm, max. w 1.6 cm, max. th 0.3 cm.

Red (2.5YR 5/8) slip on exterior and interior, hard, thin paste, non-porous, fine, red (2.5YR 5/8) fabric with some lime inclusions.

**pl. 32/103.**

**103.** (N° 1329): Body fragment; Kimistene Acropolis, southern slope, found in 2005.

Max. h 1.3 cm, max. w 2.5 cm, max. th 0.6 cm.

Red (10R 5/8) slip on exterior and interior, average hardness, thin paste, non-porous, fine, light red (2.5YR 6/8) fabric with some lime inclusions.

**pl. 32/104.**

**104.** (N° 476): Body fragment; Bath A, Room 2b, found in 2006.

Max. h 2.0 cm, max. w 2.3 cm, max. th 0.3 cm.

Red (2.5YR 5/8) slip on exterior, red (10R 5/8) slip on interior, hard, thin paste, non-porous, fine red (10R 5/6) fabric with no visible inclusions.

**pl. 32/105.**

**105.** (N° 283): Body fragment; Bath A, Room 14, found 2007.

Max. h 3.6 cm, max. w 3.4 cm, max. th 0.4 cm.

Red (10R 5/8) slip on exterior, its below part light red (2.5 YR 7/6) unslipped surface, red (10R 5/8) slip on interior, hard, non-porous, thin paste, change of colour on fabric, light red (2.5YR 6/6) and reddish yellow (5YR 7/6) fabric with some micaceous inclusions.

**pl. 32/106.**

**106.** (N° 1482): Body fragment; Monumental Tomb; found 2007.

Max. h 3.5 cm, max. w 4.1 cm, max. th 0.4 cm.

Red (10R 5/8) slip on exterior and interior, hard, thin paste, non-porous, fine, red (10R 5/8) fabric with some sand inclusions.

**pl. 32/107.**

**107.** (N° 509): Body fragment; from the field surveys in Hadrianopolis, found in 2005.

Max. h 1.5 cm, max. w 2.1 cm, max. th 0.3 cm.

Red (10R 5/8) slip on exterior and interior, hard, thin paste, non-porous, fine, red (2.5YR 5/8) fabric with no visible inclusions.

**pl. 32/108.**

**108.** (N° 588): Body fragment; Kimistene Acropolis, southern slope, just below the summit, up to Dereemail creek, found in 2005.

Max. h 2.0 cm, max. w 1.9 cm, max. th 0.4 cm.

Light red (2.5YR 6/8) unslipped surface on exterior, red (10R 5/8) slip on interior, hard, thin paste, non-porous, fine, light red (2.5YR 6/6) fabric with some lime inclusions.

**pl. 32/109.**

**109.** (N° 1425): Body fragment; Church B, found in 2005.

Max. h 1.8 cm, max. w 2.2 cm, max. th 0.5 cm.

Red (10R 5/8) slip on exterior, red (2.5YR 5/8) slip on interior, hard, thin paste, non-porous, fine, light red (2.5YR 6/8) fabric with very little micaceous and rare sand inclusions.

**pl. 32/110.**

**110.** (N° 414): Body fragment; from the field surveys in Hadrianopolis, found in 2005.

Max. h 2.4 cm, max. w 1.5 cm, max. th 0.4 cm.

Reddish yellow (5YR 7/6) unslipped surface on exterior, light red (2.5YR 6/8) slip on interior, thin paste, average hardness, fine, reddish yellow (5YR 7/6) fabric with some lime inclusions.

**pl. 32/111.**

**111.** (N° 527): Body fragment; Bath A, Room 2b, found in 2006.

Max. h 2.1 cm, max. w 1.8 cm, max. th 0.4 cm.

Light red (2.5YR 6/8) slip on exterior, red (10R 5/8) slip on interior, average hardness, thin paste, non-porous, fine, reddish yellow (5YR 7/6) fabric with no visible inclusions.

**pl. 32/112.**

**112.** (N° 1142): Body fragment; Kimistene Acropolis, found in 2005.

Max. h 1.5 cm, max. w 1.4 cm, max. th 0.3 cm.

Red (10R 5/8) slip on exterior, red (10R 5/6) slip on interior, average hardness, thin paste, non-porous, fine, light red (2.5YR 6/6) fabric with some lime inclusions.

**pl. 32/113.**

**113.** (N° 543): Body fragment; Bath A, Room 2b, found in 2006.

Max. h 1.4 cm, max. w 1.8 cm, max. th 0.4 cm.

Red (10R 5/6) slip on exterior, red (10R 5/8) slip on interior, hard, thin paste, non-porous, fine, light red (2.5YR 6/6) fabric with some micaceous inclusions.

**pl. 32/114.**

**114.** (N° 961): Body fragment; Kimistene Acropolis, found in 2005.

Max. h 1.5 cm, max. w 1.5 cm, max. th 0.4 cm.

Red (2.5YR 5/6) and reddish brown (2.5YR 5/4) mottled slip on exterior, red (2.5YR 5/8) slip on interior, hard, thin paste, sparsely porous, fired to light red (2.5YR 6/6) fabric with some sand inclusions.

**pl. 32/115.**

**115.** (N° 437): Body fragment; from the field surveys in Hadrianopolis, found in 2005.

Max. h 1.8 cm, max. w 1.8 cm, max. th 0.2 cm.

Red (10R 5/8) slip on exterior and interior, average hardness, thin paste, non-porous, fine, red (2.5YR 5/8) fabric with occasional lime inclusions.

**pl. 32/116.**

**116.** (N° 559): Body fragment; surface find from the village Boncuklar, found in 2005.

Max. h 1.8 cm, max. w 2.8 cm, max. th 0.3 cm.

Red (10R 5/6) slip on exterior, red (10R 5/8) slip on interior, hard, thin paste, non-porous, fine, light red (2.5YR 6/6) fabric with very little micaceous inclusions.

**pl. 32/117.**

**117.** (N° 471): Body fragment; Bath A, Room 2b, found in 2006.

Max. h 2.5 cm, max. w 2.4 cm, max. th 0.3 cm.

Red (10R 5/8) slip on exterior, light red (2.5YR 6/8) slip on interior, hard, thin paste, non-porous, fine, reddish yellow (5YR 6/6) fabric with some lime inclusions.

**pl. 32/118.**

**118.** (N° 1495): Body fragment; surface find from the village Boncuklar, found in 2005.

Max. h 2.1 cm, max. w 5.5 cm, max. th 0.5 cm.

Red (10R 5/6) slip on exterior, red (2.5YR 5/6) slip on interior, average hardness, thin paste, non-porous, fine, reddish yellow (5YR 6/6) fabric with frequent lime inclusions.

**pl. 32/119.**

**119.** (N° 1317): Body fragment; Kimistene Acropolis, southern slope, found in 2005.

There are some decoration patterns on its exterior.

Max. h 1.6 cm, max. w 0.9 cm, max. th 0.3 cm.

Red (10R 5/6) slip on exterior, light red (2.5YR 6/8) slip on interior, average hardness, thin paste, non-porous, fine, reddish yellow (5YR 6/6) fabric with no visible inclusions.

**pl. 32/120.**

**120.** (N° 567): Body fragment; surface find from the village Boncuklar, found in 2005.

Max. h 2.0 cm, max. w 1.5 cm, max. th 0.2 cm.

Red (2.5YR 5/8) slip on exterior, light red (2.5YR 6/8) thin slip on interior, hard, thin paste, non-porous, fine, light red (2.5YR 6/8) fabric with no visible inclusions.

**pl. 32/121.**

**121.** (N° 539): Body fragment; Bath A, Room 2b, found in 2006.

Max. h 1.3 cm, max. w 1.9 cm, max. th 0.3 cm.

Light reddish brown (5YR 6/3) and red (2.5YR 5/6) slip on exterior, weak red (2.5YR 5/2) slip on interior, average hardness, thin paste, non-porous, fine, light red (2.5YR 6/6) fabric with rare lime inclusions.

**pl. 32/122.**

**122.** (N° 898): Body fragment; Kimistene Acropolis, southern slope, underground cave, surface find, found in 2005.

Max. h 1.7 cm, max. w 2.4 cm, max. th 0.6 cm.

Light red (2.5YR 6/8) slip on exterior, red (10R 5/8) slip on interior, hard, thin paste, non-porous, fired to red (10R 5/8) fabric with no visible inclusions.

**pl. 32/123.**

**123.** (N° 549): Body fragment; surface find from the village Boncuklar, found in 2005.

Max. h 3.4 cm, max. w 4.0 cm, max. th 0.6 cm.

Thin, matt red (10R 5/8) slip on exterior and interior, average hardness, thin paste, non-porous, fine, light red (2.5YR 6/8) fabric with some micaceous inclusions.

**CLOSED FORMS** (pls. 9-11)**JUGLETS** (pl. 9)

The form is characterised by a rim with slight waist and plump body below. The outer lower edge of the everted rim is thickened with a groove on the exterior surface (n<sup>os</sup> 130-131). The neck is conical. N<sup>os</sup> 125 and 129 have everted rims. From the present body of fragments one can assume that these juglets should have a wide lower body. N<sup>os</sup> 124, 127, 133 and 134 are narrowed at the rim. The fabric has a red to reddish yellow colour and is without visible inclusions. The rim diameters differ between 5.0 and 8.4 cm.

Similar rim sherds are published in Slane 1997: 321, pl. 23, FW 250 and Kenrick 1985: 310, pl. 58, B 450, 452.

**pl. 33/124.**

**124.** (N° 576): Rim fragment; from the field surveys in Hadrianopolis, found in 2005.

Max. h 1.4 cm, max. w 1.6 cm, max. th 0.3 cm.

Red (10R 5/6) slip on exterior, red (10R 5/8) slip on interior, hard, thin paste, non-porous, fine, reddish yellow (5YR 7/6) fabric with no visible inclusions.

**pl. 9/125 and pl. 33/125.**

**125.** (N° 303): Rim fragment; Bath A, Room 2b, found in 2006.

Max. h 1.6 cm, max. w 2.6 cm, max. th 0.4 cm.

Red (10R 5/8) slip on exterior and interior, rough surface on interior, average hardness, fine, red (10R 5/8) fabric with some sand inclusions.

**pl. 9/126 and pl. 33/126.**

**126.** (N° 228): Rim fragment; Bath A, Room 13, found in 2006.

Max. h 5 cm, max. w 2.5 cm, max. th 0.3 cm.

Reddish brown (2.5YR 4/4) and weak red (10R 4/4) mottled slip on exterior, red (10R 5/6) slip on interior rim, its lower part light red (2.5YR 7/6) unslipped surface, average hardness, thin paste, non-porous, fine, reddish yellow (5YR 7/6) fabric with no visible inclusions.

**pl. 9/127 and pl. 33/127.**

**127.** (N° 1191): Rim fragment; Kepez, Cistern, surface find, found in 2005.

Max. h 1.4 cm, d of rim 5.0 cm, max. w 2.8 cm, max. th 0.3 cm.

Red (10R 5/8) slip exterior and interior, thin paste, soft, fine, light red (2.5YR 6/6) fabric with no visible inclusions.

Ateş 2003: 178, Taf. 60, n° 337.

**pl. 9/128 and pl. 33/128.**

**128.** (N° 300): Rim fragment; Bath A, Room 2b, found in 2006.

Max. h 4.0 cm, d of rim 5.6 cm, max. w 3.4 cm, max. th 0.3 cm.

Red (10R 5/8) slip on exterior, light red (2.5YR 6/8) slip on interior, very sparsely porous, thin paste, hard, fine, reddish yellow (5YR 7/6) fabric with tiny infrequent lime inclusions.

Ateş 2003: 178, Taf. 60, n° 337.

**pl. 9/129 and pl. 33/130.**

**129.** (N° 266): Rim fragment; Bath A, Room 3, illegal excavation pit, found in 2006.

Max. h 2.5 cm, d of rim 5.8 cm, max. w 4.4 cm, max. th 0.3 cm.

Light red (10R 6/8) slip on exterior, light red (10R 6/8) slip on interior rim, its below part light red (2.5YR 7/8) unslipped surface, thin paste, non-porous, hard, fine, light red (2.5YR 6/8) fabric with no visible inclusions.

Similar rim: Slane 1997: 321, pl. 23, FW 250.

1<sup>st</sup> cent. B.C.

**pl. 9/130 and pl. 33/129.**

**130.** (N° 301): Rim fragment; Bath A, Room 2b, found in 2006.

Max. h 1.7 cm, d of rim 6.8 cm, max. w 2.5 cm, max. th 0.3 cm.

Red (10R 5/8) slip on exterior and interior, porous, thin paste, hard, fine, light red (10R 6/8) fabric with infrequent lime inclusions.

Kenrick 1985: 310, pl. 58, B450.

**pl. 9/131 and pl. 33/132.**

**131.** (N° 209): Rim fragment; Bath A, Room 1, found in 2006.

Max. h 2.1 cm, d of rim 7.2 cm, max. w 3.8 cm, max. th 0.2 cm.

Reddish brown (2.5YR 4/3) slip on exterior, metallic shiny reddish brown (5YR 5/3) and reddish yellow (5YR 6/6) mottled slip on interior, thin paste, average hardness, fine, reddish yellow (5YR 7/6) fabric with no visible inclusions.

Similar rim in Slane 1997: 321, pl. 23, FW 250.

1<sup>st</sup> cent. B.C.

**pl. 9/132 and pl. 33/131.**

**132.** (N° 233): Rim fragment; Bath A, Room 13, found in 2006.

Max. h 3.6 cm, d of rim 7.8 cm, max. w 7.5 cm, max. th 0.3 cm.

Light red (2.5YR 6/8) slip on exterior, light red (10R 6/8) slip on interior rim, its below part light red (2.5YR 6/8) slip, very sparsely porous, thin paste, fine, light red (10R 6/8) fabric with no visible inclusions.

**pl. 9/133 and pl. 33/133.**

**133.** (N° 1488): Rim fragment; surface find from the village Boncuklar, found in 2005.

Joint fragment with n°134.

Max. h 1.4 cm, d of rim 8.4 cm, max. w 2.7 cm, max. th 0.3 cm.

Red (10R 5/6) slip on exterior and interior, sparsely porous, hard, fine, reddish yellow (5YR 6/6) fabric with rare lime inclusions.

Williams 1989: 18, ESA, fig. 7, n° 99.

**pl. 33/134.**

**134.** (N° 1491): Rim fragment; surface find from the village Boncuklar, found in 2005.

Max. h 1.4 cm, d of rim 8.4 cm, max. w 2.4 cm, max. th 0.3 cm.

Red (10R 5/6) slip on exterior and interior, sparsely porous, fine, hard, reddish yellow (5YR 6/6) fabric with rare lime inclusions.

**BASE FRAGMENTS OF CLOSED FORMS (pl. 10)****pl. 34/135.**

**135.** (N° 558): Base fragment; surface find from the village Boncuklar, found in 2005.

Max. h 1.3 cm, max. w 3.3 cm, max. th 0.5 cm.

Weak red (2.5YR 4/2) slip, reddish yellow (7.5YR 7/6) unslipped surface on exterior, reddish yellow (7.5YR 7/6) unslipped surface on interior, reddish yellow (5 YR 6/6) fabric with no visible inclusions.

**pl. 34/136.**

**136.** (N° 423): Base fragment; Absidal Building, found in 2007.

Max. h 3.3 cm, max. w 3.8 cm, max. th 0.6 cm.

Red (10R 5/6) and weak red (10R 5/2) slip on exterior, light red (2.5YR 7/6) unslipped surface on interior, thin paste, non-porous, hard, fine, light red (2.5YR 7/6) fabric with some micaceous inclusions.

**pl. 34/137.**

**137.** (N° 409): Base fragment; from the field surveys in Hadrianopolis, found in 2005.

Ring foot.

Max. h 1.0 cm, max. w 2.1 cm, max. th 0.4 cm.

Light red (2.5YR 7/6) unslipped surface on exterior and interior, thin paste, non-porous, hard, fine, light red (2.5YR 7/6) fabric with no visible inclusions.

**pl. 10/138 and pl. 34/141.**

**138.** (N° 289): Base fragment; Bath A, Room 2b, found in 2006.

High ring base with high form.

Max. h 1.8 cm, d of base 4.0 cm, max. w 5.8 cm, max. th 0.4 cm.

Reddish yellow (5YR 7/6) surface on exterior and upper part yellowish red (5YR 5/6) slip, reddish yellow (5YR 7/6) unslipped surface on interior, hard, fine, reddish yellow (5YR 6/6) fabric with no visible inclusions.

**pl. 10/139 and pl. 34/140.**

**139.** (N° 194): Base fragment; Bath A, Room 5, found in 2006.

Max. h 1.8 cm, d of base 4.5 cm, max. w 4.2 cm, max. th 0.5 cm.

Pink (7.5YR 7/4) unslipped surface and light red (2.5YR 6/8) slip on exterior, pink (7.5YR 7/3) unslipped surface on interior, hard, very sparsely porous, fine, pink (7.5YR 7/4) fabric with some lime and micaceous inclusions.

**pl. 10/140 and pl. 34/144.**

**140.** (N° 1494): Base fragment; surface find from the village Boncuklar, found in 2005.

Max. h 2.2 cm, d of base 4.6 cm, max. w 4.9 cm, max. th 0.5 cm.

Light red (10R 6/8) unslipped surface on exterior and interior, hard, thin paste, non-porous, fine, light red (10R 6/6) fabric with no visible inclusions.

**pl. 10/141 and pl. 34/138.**

**141.** (N° 340): Base fragment; Bath B, Room 1, found in 2007.

Max. h 1.1 cm, d of base 4.8 cm, max. w 4.3 cm, max. th 0.4 cm.

Reddish yellow (5YR 7/6) unslipped surface on exterior and interior, thin paste, sparsely porous, hard, reddish yellow (7.5 YR 7/6) fabric with some sand and lime inclusions.

**pl. 34/139.**

**142.** (N° 945): Base fragment; Kimistene Acropolis, found in 2005.

Max. h 2.2 cm, max. w 2.5 cm, max. th 0.6 cm.

Light red (2.5YR 6/6) unslipped surface on exterior and interior, thin paste, very sparsely porous, fine light red (2.5YR 6/8) fabric with some sand inclusions.

**pl. 34/143.**

**143.** (N° 294): Base fragment; Bath A, Room 2b, found in 2006.

Max. h 0.7 cm, d of base 5.0 cm, max. w 3.5 cm, max. th 0.4 cm.

Light red (2.5YR 7/6) unslipped surface on exterior and interior, hard, thin paste, sparsely porous, fine, light red (2.5YR 6/8) fabric with some micaceous and infrequent sand inclusions.

**pl. 10/144 and pl. 34/146.**

**144.** (N° 273): Base fragment; Bath A, Room 14, found in 2007.

Small bowl/cup with flat base.

Max. h 2.8 cm, d of foot 5.2 cm, max. w 3.9 cm, max. th 0.6 cm.

Red (2.5YR 5/8) and reddish brown (2.5YR 4/3) mottled slip on exterior, light red (2.5YR 7/6) surface in

interior, hard, thin paste, non-porous, fine, light red (2.5YR 6/8) fabric with infrequent sand inclusions.

**pl. 10/145 and pl. 34/142.**

**145.** (N° 276): Base fragment; Bath A, Room 14, found in 2007.

Max. h 1.1 cm, d of base 5.4 cm, max. w 4.0 cm, max. th 0.6 cm.

Red (2.5YR 5/8) unslipped surface on exterior and interior, hard, thin paste, fine, light red (10R 6/8) fabric with no visible inclusions.

**pl. 10/146 and pl. 34/145.**

**146.** (N° 286): Base fragment; Bath A, Room 14, found in 2007.

Max. h 1.1 cm, d of base 5.6 cm, max. w 5.6 cm, max. th 0.6 cm.

Red (10R 5/8) slip on exterior, thin, weak red (10R 5/4) abrasion slip on interior, hard, thin paste, fine, reddish yellow (5YR 7/6) fabric with some lime and infrequent sand inclusions.

**pl. 10/147 and pl. 34/147.**

**147.** (N° 1490): Base fragment; surface find from the village Boncuklar, found in 2005.

Max. h 1.2 cm, d of base 6.2 cm, max. w 3.1 cm, max. th 0.3 cm.

Red (10R 5/6) slip on exterior and interior, hard, thin paste, non-porous, fine, light red (10R 6/8) fabric with no visible inclusions.

**pl. 10/148 and pl. 34/148.**

**148.** (N° 288): Base fragment; Bath A, Room 2b, found in 2006.

A concave body with a high and narrow ring base<sup>42</sup>. Very strong wheel-marks in exterior and interior surface. A stamped decoration in the interior.

Max. h 3.3 cm, d of base 7.2 cm, max. w 5.5 cm, max. th 0.6 cm.

Pink (5YR 7/4) unslipped surface on exterior, thin red (10R 5/6) slip on interior, thin paste, hard, non-porous, change of colour on fabric, pink (5YR 7/4) and light reddish brown (2.5YR 7/4) fabric with no visible inclusions

**HANDLE FRAGMENTS OF CLOSED FORMS (pl. 11)**

Two type of handles have been observed: plain and grooved.

**pl. 35/149.**

**149.** (N° 903): Handle fragment; Kimistene Acropolis, southern slope, underground cave, surface find, found in 2005.

Max. h 2.6 cm, max. w 1.6 cm, max. th 0.6 cm.

Thin red (10R 5/6) slip on exterior and interior, very sparsely porous, thin paste, hard, fine, light red (2.5YR 7/6) fabric with no visible inclusions.

42) Similar to Mitsopoulos-Leon 1991: 124, pl. 173, n° 125.

**pl. 35/150.**

**150.** (N° 304): Handle fragment; Bath A, Room 2b, found in 2006.

Max. h 2.4 cm, max. w 1.1 cm, max. th 0.6 cm.

Red (10R 5/8) slip on exterior and interior, non-porous, thin paste, hard, fine, light red (2.5YR 6/6) fabric with fabric with infrequent lime inclusions.

**pl. 35/151.**

**151.** (N° 552): Handle fragment; surface find from the village Boncuklar, found in 2005.

Max. h 2.3 cm, max. w 1.5 cm, max. th 0.7 cm.

Red (2.5YR 5/8) slip on exterior and interior, non-porous, thin paste, hard, fine, light red (2.5YR 6/8) fabric with rare sand inclusions.

**pl. 35/152.**

**152.** (N° 237): Handle fragment; Bath A, Room 12, found in 2006.

Parted in three through grooves.

Max. h 3.5 cm, max. w 2.1 cm, max. th 0.6 cm.

Red (10R 5/6) slip on exterior, red (10R 5/8) slip on interior, non-porous, thin paste, hard, fine, light red (10R 6/8) fabric with some micaceous inclusions.

**pl. 35/153.**

**153.** (N° 958): Handle fragment; Kimistene Acropolis, found in 2005.

Max. h 2.2 cm, max. w 1.3 cm, max. th 0.5 cm.

Thin, matt red (10R 5/6) slip on exterior, red (10R 5/8) slip on interior, non-porous, thin paste, hard, fine, red (10R 5/6) fabric with some lime and infrequent sand inclusions.

**pl. 11/154 and pl. 35/154.**

**154.** (N° 278): Handle fragment; Bath A, Room 14, found in 2006.

Max. h 2.9 cm, max. w 2.2 cm, max. th 0.6 cm.

Thin, shiny red (2.5YR 5/8) slip on exterior and interior, sparsely porous, hard, fine, light red (2.5YR 7/6) fabric with no visible inclusions.

**pl. 11/155 and pl. 35/155.**

**155.** (N° 246): Handle fragment; Western Tomb, found in 2007.

Max. h 3.5 cm, max. w 1.5 cm, max. th 0.6 cm.

Red (10R 5/8) slip on exterior and interior, thin paste, average hardness, fine, reddish yellow (5YR 7/6) fabric with infrequent lime inclusions.

**pl. 35/156.**

**156.** (N° 857): Handle fragment; Kimistene Acropolis, northwestern slope of the temple, found in 2005.

Max. h 1.6 cm, max. w 1.5 cm, max. th 0.4 cm.

Light red (2.5YR 6/8) unslipped surface on exterior, red (2.5YR 5/8) slip on interior, hard, non-porous, fine, light red (2.5YR 6/8) fabric with no visible inclusions.

**pl. 35/157.**

**157.** (N° 82): Handle fragment; Bath B, Room 3, illegal excavation pit, found in 2007.

Max. h 3.3 cm, max. w 1.2 cm, max. th 1.1 cm.

Red (10R 5/8) slip on exterior and interior, thin paste, non-porous, hard, fine, red (2.5YR 5/8) fabric with no visible inclusions.

**pl. 35/158.**

**158.** (N° 169): Handle fragment; *Domus*, found in 2007.

Max. h 2.6 cm, max. w 1.7 cm, max. th 0.7 cm.

Thin, abrasion, red (10R 5/8) slip on exterior and interior, sparsely porous, thin paste, hard, fine, red (10R 5/8) fabric with some sand inclusions.

**pl. 35/159.**

**159.** (N° 324): Handle fragment; Bath A, Room 2b, found in 2006.

Max. h 3.3 cm, max. w 1.2 cm, max. th 0.5 cm.

Light red (2.5YR 6/8) slip on exterior and interior, thin paste, non-porous, hard, fine, light red (2.5YR 6/8) fabric with no visible inclusions.

**pl. 35/160.**

**160.** (N° 325): Handle fragment; Bath A, Room 2b, found in 2006.

Max. h 2.3 cm, max. w 1.2 cm, max. th 0.6 cm.

Light red (2.5YR 6/6) slip on exterior and interior, average hardness, thin paste, non-porous, fine, light red (2.5YR 7/8) fabric with some sand and lime inclusions.

**BODY FRAGMENTS OF CLOSED FORMS (pl. 36)**

The fabric colour is reddish yellow to red and the exterior slip reddish brown to red.

**pl. 36/161.**

**161.** (N° 323): Body fragment; Bath A, Room 2b, found in 2006.

Max. h 2.5 cm, max. w 2.6 cm, max. th 0.3 cm.

Reddish brown (2.5YR 4/4) slip on exterior, pink (5YR 7/4) unslipped surface on interior, very sparsely porous, thin paste, average hardness, fine, reddish yellow (5YR 7/6) fabric with no visible inclusions.

**pl. 36/162.**

**162.** (N° 280): Body fragment; Bath A, Room 1, found in 2006.

Max. h 2.4 cm, max. w 2.1 cm, max. th 0.3 cm.

Reddish brown (2.5YR 4/3) and dusky red (2.5YR 3/2) mottled slip on exterior, reddish yellow (5YR 7/6) unslipped surface on interior, very sparsely porous, thin paste, average hardness, fine, reddish yellow (5YR 6/6) fabric with very little micaceous inclusions.

**pl. 36/163.**

**163.** (N° 319): Body fragment; Bath A, Room 2b, found in 2006.

Max. h 3.1 cm, max. w 3.7 cm, max. th 0.4 cm.

Reddish brown (5YR 4/4) slip on exterior, reddish yellow (5YR 7/6) unslipped surface on interior, very sparsely porous, thin paste, hard, fine, reddish yellow (5YR 6/8) fabric with no visible inclusions.

**pl. 36/164.**

**164.** (N° 312): Body fragment; Bath A, Room 2b, found in 2006.

Max. h 2.5 cm, max. w 2.7 cm, max. th 0.5 cm.

Red (10R 5/6) slip on exterior, its below part reddish gray (10R 5/1) slip, pink (5YR 7/4) unslipped surface on interior, non-porous, thin paste, hard, fine, pink (7.5YR 7/4) fabric with very little micaceous inclusions.

**pl. 36/165.**

**165.** (N° 562): Body fragment; surface find from the village Boncuklar, found in 2005.

Max. h 1.9 cm, max. w 2.9 cm, max. th 0.4 cm.

Matt reddish brown (2.5YR 4/3) slip on exterior, its below part pink (5YR 7/4) unslipped surface on exterior, light red (2.5YR 7/6) unslipped surface on interior, average hardness, thin paste, non-porous, fired to light red (2.5YR 6/6) fabric with some lime inclusions.

Pierced by a hole.

**pl. 36/166.**

**166.** (N° 200): Body fragment; Bath A, Room 5, found in 2006.

Max. h 1.8 cm, max. w 1.6 cm, max. th 0.4 cm.

Red (2.5YR 5/6) slip on exterior, pinkish lime (7.5YR 8/2) unslipped surface on interior, thin paste, hard, fired to pink (5YR 7/4) fabric with no visible inclusions.

**pl. 36/167.**

**167.** (N° 321): Body fragment; Bath A, Room 2b, found in 2006.

Max. h 2.4 cm, max. w 2.7 cm, max. th 0.3 cm.

Red (2.5YR 5/6) slip on exterior, light red (2.5YR 6/8) unslipped surface on interior, very sparsely porous, thin paste, hard, change of colour on fabric, light red (10R 6/8) and reddish yellow (5YR 7/8) fabric with no visible inclusions.

**pl. 36/168.**

**168.** (N° 528): Body fragment; Bath A, Room 2b, found in 2006.

Max. h 2.4 cm, max. w 2.7 cm, max. th 0.4 cm.

Reddish brown (2.5YR 5/3) slip on exterior, light red (2.5YR 7/6) unslipped surface on interior, average hardness, thin paste, hard, fine, reddish yellow (5YR 7/6) fabric with no visible inclusions.

**pl. 36/169.**

**169.** (N° 530): Body fragment; Bath A, Room 14, found in 2007.

Max. h 2.4 cm, max. w 2.2 cm, max. th 0.3 cm.

Reddish brown (2.5YR 4/4) and red (2.5YR 4/6) mottled slip on exterior, reddish yellow (5YR 7/6) unslipped surface on interior, thin paste, non-porous, hard, fired to reddish yellow (5YR 6/6) fabric with some sand and lime inclusions.

**pl. 36/170.**

**170.** (N° 551): Body fragment; surface find from the village Boncuklar, found in 2005.

Max. h 3.2 cm, max. w 3.2 cm, max. th 0.4 cm.

Weak red (10R 5/4) mottled slip on exterior, reddish yellow (5YR 6/6) unslipped surface on interior, average hardness, very sparsely porous, hard, fine, reddish yellow (5YR 7/6) fabric with infrequent micaceous inclusions.

**pl. 36/171.**

**171.** (N° 268): Body fragment; Bath A, Room 3, illegal excavation pit, found in 2006.

Max. h 3.6 cm, max. w 3.5 cm, max. th 0.4 cm.

Matt yellowish red (5YR 6/6) slip on exterior, reddish yellow (5YR 7/6) unslipped surface on interior, average hardness, non-porous, thin paste, fine, yellowish red (5YR 6/6) fabric with some micaceous and lime inclusions.

**pl. 36/172.**

**172.** (N° 899): Body fragment; Kimistene Acropolis, southern slope, underground cave, found in 2005.

Max. h 2.3 cm, max. w 2.2 cm, max. th 0.3 cm.

Metallic, shiny weak red (10R 4/4) slip on exterior, pink (5YR 7/4) unslipped surface on interior, non-porous, thin paste, hard, fine, light red (2.5YR 7/6) fabric with no visible inclusions.

**pl. 36/173.**

**173.** (N° 479): Body fragment; Bath A, Room 2b, found in 2006.

Max. h 1.5 cm, max. w 1.6 cm, max. th 0.3 cm.

Metallic, shiny reddish brown (2.5YR 4/4) slip on exterior, light red (2.5YR 6/6) unslipped surface on interior, non-porous, thin paste, hard, fine, light red (10R 6/8) fabric with no visible inclusions.

**pl. 36/174.**

**174.** (N° 202): Body fragment; Bath A, Room 13a, found in 2006.

Max. h 2.6 cm, max. w 2.7 cm, max. th 0.3 cm.

Metallic shiny reddish brown (2.5YR 4/4) slip on exterior, pink (2.5 YR 8/4) unslipped surface on interior, thin paste, very sparsely porous, hard, fine, reddish yellow (5YR 7/6) fabric with no visible inclusions.

**pl. 36/175.**

**175.** (N° 413): Body fragment; from the field surveys in Hadrianopolis, found in 2005.

Max. h 2.4 cm, max. w 3.0 cm, max. th 0.3 cm.

Red (10R 5/6) and weak red (10R 4/4) mottled slip on exterior, red (10R 5/8) slip and light red (10R 6/6) unslipped surface on interior, hard, thin paste, fine, red (10R 5/8) fabric with very little micaceous inclusions.

**pl. 36/176.**

**176.** (N° 318): Body fragment; Bath A, Room 2b, found in 2006.

Max. h 2.6 cm, max. w 3.9 cm, max. th 0.2 cm.

Shiny red (10R 4/6) slip on exterior, smoothed surface on exterior, reddish brown (2.5YR 5/4) unslipped surface on interior, thin paste, reddish brown (2.5YR 5/4) fabric with infrequent tiny sand inclusions.

Traces of a handle splaying place (d 1.2 cm) is on its exterior side.

**pl. 36/177.**

**177.** (N° 930): Body fragment; Bath A, found in 2006.

Max. h 2.0 cm, max. w 1.9 cm, max. th 0.2 cm.

Red (10R 5/6) and red (2.5YR 4/8) slip on exterior, light reddish brown (2.5YR 7/4) unslipped surface on interior, thin paste, hard, non-porous, fine, red (2.5YR 5/6) fabric with no visible inclusions.

Traces of a handle splaying place (d 1.6 cm) is on its exterior side.

**pl. 36/178.**

**178.** (N° 282): Body fragment; Bath A, Room 14, found in 2007.

Max. h 3.3 cm, max. w 3.2 cm, max. th 0.4 cm.

Red (10R 5/8) slip on exterior, red (10R 5/8) unslipped surface on interior, thin paste, hard, fine, red (10R 5/8) fabric with infrequent lime inclusions. Well-fired with a thick wall.

**pl. 36/179.**

**179.** (N° 189): Body fragment; Bath A, Room 4, found in 2006.

Max. h 3.0 cm, max. w 3.7 cm, max. th 0.4 cm.

Shiny red (2.5YR 4/8) slip on exterior, light red (10R 6/8) unslipped surface on interior, very sparsely porous, thin paste, hard, fine, light red (10R 6/8) fabric with no visible inclusions.

**pl. 36/180.**

**180.** (N° 906): Body fragment; Bath A, found in 2006.

Max. h 2.0 cm, max. w 2.0 cm, max. th 0.2 cm.

Red (10R 5/8) slip on exterior, light red (2.5YR 7/6) unslipped surface on interior, thin paste, hard, non-porous, fine, light red (2.5YR 6/6) fabric with no visible inclusions.

**pl. 36/181.**

**181.** (N° 199): Body fragment; Bath A, Room 5, found in 2006.

Max. h 2.3 cm, max. w 2.6 cm, max. th 0.3 cm.

Red (10R 5/8) slip on exterior, light red (10R 6/8) unslipped surface on interior, non-porous, thin paste, hard, fine, red (10R 5/8) fabric with no visible inclusions.

**pl. 36/182.**

**182.** (N° 477): Body fragment; Kimistene Acropolis, southern slope, found in 2005.

Max. h 1.4 cm, max. w 2.2 cm, max. th 0.3 cm.

Reddish brown (5YR 4/3) and reddish yellow (5YR 6/6) mottled slip on exterior, light reddish brown (5YR 6/4) unslipped surface on interior, non-porous, thin paste, average hardness, fine, reddish yellow (5YR 6/6) fabric with infrequent lime inclusions.

**pl. 36/183.**

**183.** (N° 223): Body fragment; Bath A, Room 13, found in 2006.

Max. h 3.2 cm, max. w 3.2 cm, max. th 0.3 cm.

Red (10R 5/8) slip on exterior, light red (2.5YR 7/6) unslipped surface on interior, smoothed surface, hard, thin paste, non-porous, fine, light red (2.5YR 6/8) fabric with some micaceous inclusions.

**pl. 36/184.**

**184.** (N° 532): Body fragment; Bath A, Room 2b, found in 2006.

Max. h 2.8 cm, max. w 1.9 cm, max. th 0.3 cm.

Red (10R 5/8) slip on exterior, light red (2.5YR 6/8) unslipped surface on interior, hard, thin paste, non-porous, fine, light red (10R 6/8) fabric with no visible inclusions.

**pl. 36/185.**

**185.** (N° 535): Body fragment; Bath A, Room 2b, found in 2006.

Max. h 2.5 cm, max. w 1.6 cm, max. th 0.4 cm.

Red (2.5YR 5/8) slip on exterior, light red (2.5YR 7/8) unslipped surface on interior, hard, thin paste, non-porous, fired to light red (2.5YR 6/8) fabric with infrequent micaceous inclusions.

**pl. 36/186.**

**186.** (N° 229): Body fragment; Bath A, Room 13, found in 2006.

Max. h 2.3 cm, max. w 2.1 cm, max. th 0.4 cm.

Red (10R 5/6) slip on exterior, reddish yellow (5YR 7/6) unslipped surface on interior, thin paste, non-porous, average hardness, fine, light red (2.5YR 6/6) fabric with infrequent sand inclusions.

**pl. 36/187.**

**187.** (N° 203): Body fragment; Bath A, Room 13a, found in 2006.

Max. h 1.9 cm, max. w 2.0 cm, max. th 0.2 cm.

Red (2.5YR 5/8) slip on exterior, light red (2.5YR 7/6) unslipped surface on interior, hard, thin paste, non-porous, fine, light red (2.5YR 7/6) fabric with no visible inclusions.

**pl. 36/188.**

**188.** (N° 1314): Body fragment; Kimistene Acropolis, southern slope, found in 2005.

Max. h 2.2 cm, max. w 2.1 cm, max. th 0.2 cm.

Red (10R 5/8) slip on exterior, light red (2.5YR 7/6) unslipped surface on interior, hard, thin paste, non-porous, fine, light red (2.5YR 6/8) fabric with no visible inclusions.

**pl. 36/189.**

**189.** (N° 578): Body fragment; from the field surveys in Hadrianopolis, found in 2005.

Max. h 1.5 cm, max. w 1.7 cm, max. th 0.4 cm.

Red (10R 5/8) slip on exterior, light red (2.5YR 7/6) unslipped surface on interior, hard, thin paste, non-porous, fine, light red (2.5YR 6/6) fabric with no visible inclusions.

**pl. 36/190.**

**190.** (N° 475): Body fragment; Bath A, Room 2b, found in 2006.

Max. h 1.8 cm, max. w 3.3 cm, max. th 0.3 cm.

Red (10R 5/8) slip on exterior, light red (2.5YR 7/6) unslipped surface on interior, hard, thin paste, non-porous, fine, light red (2.5YR 6/8) fabric with infrequent lime inclusions.

**pl. 36/191.**

**191.** (N° 315): Body fragment; Bath A, Room 2b, found in 2006.

Max. h 6.0 cm, max. w 5.8 cm, max. th 0.5 cm.

Red (10R 5/8) slip on exterior, its below part reddish yellow (5YR 7/6) unslipped surface, reddish yellow (5YR 7/6) unslipped surface on interior, thin paste, very sparsely porous, hard, fine, reddish yellow (5YR 7/6) fabric occasional micaceous and lime inclusions.

**pl. 36/192.**

**192** (N° 553): Body fragment; surface find from the village Boncuklar, found in 2005.

Max. h 1.3 cm, max. w 1.9 cm, max. th 0.3 cm.

Red (10R 5/8) slip on exterior, reddish yellow (7.5Yr 7/6) unslipped surface on interior, hard, thin paste, non-porous, fine, reddish yellow (5YR 7/6) fabric with no visible inclusions.

**pl. 36/193.**

**193.** (N° 1480): Body fragment; Monumental Tomb, found in 2006.

Max. h 1.5 cm, max. w 1.5 cm, max. th 0.3 cm.

Red (10R 5/8) slip on exterior, pink (7.5YR 7/4) unslipped surface on interior, hard, thin paste, non-porous, fine, light red (2.5YR 6/6) fabric with no visible inclusions.

**pl. 36/194.**

**194.** (N° 531): Body fragment; Bath A, Room 2b, found in 2006.

Max. h 2.5 cm, max. w 2.8 cm, max. th 0.5 cm.

Red (2.5YR 4/8) slip on exterior, red (10R 5/8) unslipped surface on interior, average hardness, thin paste, non-porous, fine, red (10R 5/8) fabric with no visible inclusions.

**pl. 36/195.**

**195.** (N° 572): Body fragment; surface find from the village Boncuklar, found in 2005.

Max. h 0.9 cm, max. w 1.4 cm, max. th 0.2 cm.

Red (10R 5/8) slip on exterior, pink (7.5YR 7/4) unslipped surface on interior, hard, thin paste, non-porous, fine, reddish yellow (5YR 6/6) fabric with no visible inclusions.

**pl. 36/196.**

**196.** (N° 1332): Body fragment; Kimistene Acropolis, southern slope, found in 2005.

Max. h 2.0 cm, max. w 2.0 cm, max. th 0.2 cm.

Red (10R 5/8) slip on exterior, light red (2.5YR 6/8) unslipped surface on interior, thin paste, hard, very sparsely porous, fine, light red (2.5YR 6/6) fabric with some sand inclusions.

**pl. 36/197.**

**197.** (N° 541): Body fragment; Bath A, Room 2b, found in 2006.

Max. h 1.3 cm, max. w 1.5 cm, max. th 0.3 cm.

Red (10R 5/8) slip on exterior, light red (2.5YR 7/6) unslipped surface on interior, hard, thin paste, non-porous, fine, light red (2.5YR 6/8) fabric with no visible inclusions.

**pl. 36/198.**

**198.** (N° 560): Body fragment; surface find from the village Boncuklar, found in 2005.

Max. h 0.9 cm, max. w 1.7 cm, max. th 0.2 cm.

Red (10R 5/8) slip on exterior, pink (5YR 7/4) unslipped surface on interior, hard, thin paste, non-porous, fine, reddish yellow (5YR 6/6) fabric with no visible inclusions.

**pl. 36/199.**

**199.** (N° 408): Body fragment; from the field surveys in Hadrianopolis, found in 2005.

Max. h 2.5 cm, max. w 1.5 cm, max. th 0.4 cm.

Red (10R 5/8) slip on exterior, reddish yellow (5YR 7/6) unslipped surface on interior, hard, thin paste, non-porous, fine, reddish yellow (5YR 7/6) fabric with infrequent sand and lime inclusions.

**pl. 36/200.**

**200.** (N° 272): Body fragment; Bath A, Room 3, illegal excavation pit, found in 2006.

Max. h 2.3 cm, max. w 3 cm, max. th 0.4 cm.

Shiny red (2.5YR 5/8) slip on exterior, smoothed surface on exterior, pink (7.5YR 8/4) unslipped surface on interior, hard, thin paste, non-porous, fine, reddish yellow (5YR 7/6) fabric with some tiny sand inclusions.

Traces of a handle splaying place (d 1.8 cm) on its exterior side.

**pl. 36/201.**

**201.** (N° 291): Body fragment; Bath B, Room 8, found in 2007.

Max. h 1.7 cm, max. w 1.4 cm, max. th 0.3 cm.

Red (2.5YR 4/8) and red (10R 6/8) mottled slip on exterior, metallic shiny red (2.5YR 4/8) slip on interior, hard, thin paste, non-porous, fine, red (2.5YR 6/6) fabric with no visible inclusions.

**pl. 36/202.**

**202.** (N° 508): Body fragment; from the field surveys in Hadrianopolis, found in 2005.

Max. h 2.0 cm, max. w 2.6 cm, max. th 0.4 cm.

Thin, matt light red (10R 6/8) slip on exterior, reddish yellow (5YR 7/6) unslipped surface on interior, hard, thin paste, non-porous, fine, reddish yellow (5YR 7/6) fabric with some lime and sand inclusions.

**pl. 36/203.**

**203.** (N° 548): Body fragment; surface find from the village Boncuklar, found in 2005.

Max. h 2.7 cm, max. w 2.4 cm, max. th 0.4 cm.

Light red (2.5YR 6/6) slip on exterior, reddish yellow (5YR 7/6) unslipped surface on interior, average hardness, thin paste, non-porous, fine, light red (2.5YR 6/6) fabric with some lime inclusions.

**pl. 36/204.**

**204.** (N° 565): Body fragment; surface find from the village Boncuklar, found in 2005.

Max. h 2.0 cm, max. w 2.0 cm, max. th 0.3 cm.

Red (10R 5/8) slip on exterior, light red (2.5YR 7/6) unslipped surface on interior, average hardness, thin paste, non-porous, fine, light red (2.5YR 6/6) fabric with very little micaceous inclusions.

**pl. 36/205.**

**205.** (N° 574): Body fragment; from the field surveys in Hadrianopolis, found in 2005.

Max. h 2.1 cm, max. w 2.2 cm, max. th 0.4 cm.

Thin, matt light red (2.5YR 6/6) slip on exterior, reddish yellow (5YR 7/6) unslipped surface on interior, average hardness, thin paste, non-porous, fine, reddish yellow (5YR 6/6) fabric with some lime inclusions.

**pl. 36/206.**

**206.** (N° 322): Body fragment; Bath A, Room 2b, found in 2006.

Max. h 3.5 cm, max. w 4.7 cm, max. th 0.3 cm.

Matt yellowish red (5YR 5/8) slip on exterior, light red (2.5YR 7/6) unslipped surface on interior, smoothed slip all of surface, thin paste, sparsely porous, hard, fine, reddish yellow (5YR 7/6) fabric with occasional tiny micaceous and sand inclusions.

**pl. 36/207.**

**207.** (N° 1349): Body fragment; Kimistene Acropolis, found in 2005.

Max. h 3.0 cm, max. w 3.4 cm, max. th 0.3 cm.

Red (10R 5/8) and light red (2.5YR 6/8) mottled slip on exterior, very thin red (10R 5/8) slip on interior, thin paste, non-porous, hard, fine, light red (2.5YR 6/8) fabric with rare lime inclusions.

**pl. 36/208.**

**208.** (N° 410): Body fragment; from the field surveys in Hadrianopolis, found in 2005.

Max. h 1.9 cm, max. w 2.4 cm, max. th 0.3 cm.

Light red (2.5YR 6/8) slip on exterior, reddish yellow (5YR 7/6) unslipped surface on interior, thin paste, average hardness, non-porous, fine, reddish yellow (5YR 7/8) fabric with some lime and sand inclusions.

**pl. 36/209.**

**209.** (N° 571): Body fragment; surface find from the village Boncuklar, found in 2005.

Max. h 1.7 cm, max. w 1.4 cm, max. th 0.4 cm.

Red (10R 5/8) slip on exterior, light red (2.5YR 6/6) unslipped surface on interior, thin paste, non-porous, hard, fine, light red (10R 6/8) fabric with no visible inclusions.

**pl. 36/210.**

**210.** (N° 271): Body fragment; Bath A, Room 3, illegal excavation pit, found in 2006.

Max. h 2.0 cm, max. w 2.0 cm, max. th 0.4 cm.

Matt red (2.5YR 5/8) slip on exterior, reddish yellow (5YR 7/6) unslipped surface on interior, very sparsely porous, thin paste, hard, change of colour on fabric, light red (2.5YR 6/8) and reddish yellow (5YR 6/8) fabric with some sand inclusions.

**pl. 36/211.**

**211.** (N° 909): Body fragment; Kimistene Acropolis, southern slope, underground cave, found in 2005.

Max. h 1.7 cm, max. w 1.1 cm, max. th 0.4 cm.

Red (10R 5/8) slip on exterior, reddish yellow (5YR 6/6) unslipped surface on interior, thin paste, non-porous, hard, fine, light red (2.5YR 6/6) fabric with some lime inclusions.

**pl. 36/212.**

**212.** (N° 1315): Body fragment; Kimistene Acropolis, southern slope, found in 2005.

Max. h 1.6 cm, max. w 1.4 cm, max. th 0.3 cm.

Red (2.5YR 5/6) slip on exterior, reddish yellow (5YR 6/6) unslipped surface on interior, hard, porous, fine, reddish yellow (5YR 7/6) fabric with infrequent sand and very little micaceous inclusions.

**pl. 36/213.**

**213.** (N° 583): Body fragment; Kimistene Acropolis, southern slope, just below the summit, up to Deresemail creek, found in 2005.

Max. h 1.9 cm, max. w 2.2 cm, max. th 0.3 cm.

Light red (2.5YR 6/8) slip on exterior, pink (5YR 8/3) unslipped surface on interior, hard, porous, thin paste, fine, light red (2.5YR 7/6) fabric with no visible inclusions.

**pl. 36/214.**

**214.** (N° 231): Body fragment; Bath A, Room 13, found in 2006.

Max. h 3.9 cm, max. w 6.1 cm, max. th 0.4 cm.

Red (10R 5/8) slip on exterior, pink (5YR 7/4) unslipped surface on interior, thin paste, non-porous, hard, fine, light reddish brown (2.5YR 6/4) fabric with some micaceous inclusions.

### **RIM FRAGMENTS WITHOUT ANY FORM DEFINITION (pl. 37)**

Most of them are thin and both sides slipped. Their slip varies in colour between reddish yellow and red. The paste colour varies between light red and red. Most of them do not have any visible inclusions. A major part of them originate from Kimistene.

**pl. 37/215.**

**215.** (N° 569): Rim fragment; surface find from the village Boncuklar, found in 2005.

Open form, most probably a bowl. Similar to local sigillata, bowl form n° 1.

Max. h 1.5 cm, max. w 2.0 cm, max. th 0.4 cm.

Red (10R 4/8) slip on exterior, reddish yellow (7.5YR 7/6) unslipped surface on interior, thin paste, non-porous, hard, fine, light red (2.5YR 6/8) fabric with no visible inclusions.

**pl. 37/216.**

**216.** (N° 1261): Rim fragment; Kimistene Necropolis I, found in 2005.

Open form, most probably a bowl. Similar to local sigillata, bowl form n° 1.

Max. h 3.3 cm, max. w 2.1 cm, max. th 0.4 cm.

Red (2.5YR 5/8) and reddish brown (2.5YR 4/4) mottled slip on exterior, red (2.5YR 5/8) slip on interior, thin paste, non-porous, hard, fine, red (2.5YR 4/6) fabric with some lime inclusions.

**pl. 37/217.**

**217.** (N° 859): Rim fragment; Kimistene, Acropolis, found in 2005.

Most probably open form.

Max. h 1.3 cm, max. w 1.1 cm, max. th 0.2 cm.

Red (2.5YR 5/8) slip on exterior, red (2.5YR 4/6) slip on interior, thin paste, non-porous, hard, fine, light red (2.5YR 6/8) fabric with no visible inclusions.

**pl. 37/218.**

**218.** (N° 1138): Rim fragment; Kimistene Acropolis, found in 2005.

Most probably open form.

Max. h 0.9 cm, max. w 1.5 cm, max. th 0.5 cm.

Red (2.5YR 5/8) slip on exterior and interior, thin paste, non-porous, hard, fine, red (2.5YR 5/8) fabric with very little micaceous inclusions.

**pl. 37/219.**

**219.** (N° 959): Rim fragment; Kimistene Acropolis, found in 2005.

Open form, similar to n° 214.

Max. h 2.1 cm, max. w 1.3 cm, max. th 0.5 cm.

Red (2.5YR 5/8) slip on exterior and interior, thin paste, non-porous, hard, fine, red (2.5YR 5/8) fabric with no visible inclusions.

**pl. 37/220.**

**220.** (N° 538): Rim fragment; Bath A, Room 2b, found in 2006.

Open form.

Max. h 1.9 cm, max. w 1.5 cm, max. th 0.3 cm.

Red (2.5YR 4/8) slip on exterior, red (2.5YR 5/6) slip on interior, thin paste, non-porous, hard, fine, red (10R 5/6) fabric with some sand inclusions.

**pl. 37/221.**

**221.** (N° 309): Rim fragment; Bath A, Room 2b, found in 2006.

Max. h 1.2 cm, max. w 1.2 cm, max. th 0.4 cm.

Red (2.5YR 5/6) slip on exterior, red (2.5YR 5/8) slip on exterior, non-porous, hard, fine, reddish yellow (5YR 6/6) fabric with no visible inclusions.

**pl. 37/222.**

**222.** (N° 1316): Rim fragment; Kimistene Acropolis, southern slope, found in 2005.

Open form, most probably a bowl. Similar to local sigillata, bowl form n° 1.

Max. h 1.2 cm, max. w 1.6 cm, max. th 0.3 cm.

Shiny red (2.5YR 5/8) slip on exterior and interior, smoothed surface, non-porous, hard, thin paste, fine, light red (2.5YR 6/8) fabric with some lime inclusions.

**pl. 37/223.**

**223.** (N° 585): Rim fragment; Kimistene Acropolis, southern slope, just below the summit, up to Deresemail creek, found in 2005.

Max. h 1.3 cm, max. w 1.5 cm, max. th 0.4 cm.

Dark reddish gray (2.5YR 3/1) slip on exterior, red (2.5YR 5/8) slip on interior, non-porous, hard, thin paste, fine, red (2.5YR 5/8) fabric with no visible inclusions.

**pl. 37/224.**

**224.** (N° 593): Rim fragment; Kimistene Acropolis, southern slope, just below the summit, up to Deresemal creek, found in 2005.

Max. h 1.4 cm, max. w 1.4 cm, max. th 0.2 cm.

Pink (7.5YR 7/4) unslipped surface on exterior, shiny red (10R 5/4) slip on interior, average hardness, thin paste, non-porous, fine, pink (7.5YR 7/4) fabric with no visible inclusions.

**LAMP FRAGMENTS IN SIGILLATA TRADITION** (pl. 38)

Only two examples belonged to this form. They are evidences of lamp production in local sigillata tradition. Their fabric is of the same colour and their exterior surface has red slip.

**pl. 38/225.**

**225.** (N° 566): Discus fragment; surface find from the village Boncuklar, found in 2005.

Max. h 1.6 cm, max. w 1.4 cm, max. th 0.3 cm.

Red (2.5YR 5/8) slip on exterior, light red (2.5YR 6/8) unslipped surface on interior, thin paste, non-porous, hard, fine, red (2.5YR 5/8) fabric with no visible inclusions.

**pl. 38/226.**

**226.** (N° 295): Discus fragment; Bath A, Room 2b, found in 2006.

Max. h 1.7 cm, max. w 1.5 cm, max. th 0.5 cm.

Red (10R 5/8) slip on exterior and interior, average hardness, thin paste, non-porous, fine, red (2.5YR 5/8) fabric with some lime inclusions.

**RED-SLIPPED WARES** (pls. 12-22)

**IMPORTS** (pl. 12)

**AFRICAN RED-SLIPPED BOWL=BONIFAY 2004: 181, TYPE 55, 180, FIG. 96, N° 4** (pl. 12)

Only one rim sherd could be determined as 'African red-slipped ware'<sup>43</sup>. It is a bowl form with convex wall curving up to a rounded rim thickened on the outside. The exterior and the inside of the rim is slipped and its slip is flaking on all of the

surface. The fabric is hard and red with limestone inclusions.

**pl. 12.**

**227.** (N° 433): Rim fragment; from the field surveys in Hadrianopolis, found in 2006.

Max. h 2.2 cm, d of rim 22.4 cm, max. w 3.6 cm, max. th 0.5 cm.

Red (10R 4/8) slip on exterior and interior, hard, thin paste, non-porous, fine, red (10R 4/8) fabric with some lime inclusions.

Bonifay 2004: 181, type 55, 180, fig. 96, n° 4; Hayes 1972: 152, Form 99, fig. 28, n° 7.

Early 6<sup>th</sup> A.D.

**LOCAL RED-SLIPPED WARES-OPEN FORMS** (pls. 13-21)

There are numerous fragments of bowls, and very few dishes and plates which are only represented by base fragments. It seems that the cups and small bowls known in the previous periods are already forgotten.

**BOWLS** (pls. 13-19)

Mostly large bowl forms were made. They have taken the 3<sup>rd</sup> cent. bowl form of the Phocaeen red-slipped ware as a model and they continued to use this form until the 6<sup>th</sup>-7<sup>th</sup> cent. A.D., but in unslipped versions. These forms do not change for a long period of time. The potters behind these bowls imitate several workshops, mostly concentrating on later products, such as African and Phocaeen red-slipped wares<sup>44</sup>. It seems that the *Domus* has a great variety of 6<sup>th</sup> and 7<sup>th</sup> cent. A.D. bowls.

**BOWL FORM 1** (pl. 13)

Five fragments belong to this shallow bowl form. The rims are thickened on the exterior and connected to the body with a concave profile. The slip colour ranges from reddish brown to red. The slip is thin and matt. The fabric is reddish yellow, yellowish red, and red with sand, lime and micaceous inclusions. Rim diameters range from 22.0 to 25.2 cm. The form is similar to some Sagalassian shapes of the 4<sup>th</sup> cent. A.D.<sup>45</sup>. In Amorium it has been dated to the late 4<sup>th</sup> or 5<sup>th</sup> cent. A.D.<sup>46</sup>.

43) Similar to Paz and Vargas 2011: 90, n° 13, fig. 3.

44) Recently J. Poblome and N. Firat attempted to understand relationships between African, Cypriote, Sagalassian and other eastern red-slipped productions: Poblome and Firat 2011.

45) Poblome 1999: 309, type 1C160, fig. 61, n° 6 and type 1C170, fig. 63, n° 1, 3.

46) Harrison 1991: 224, fig. 6, n° 4, 8.

**pl. 13/228 and pl. 39/228.**

**228.** (N° 1266): Rim fragment; Kimistene, Necropolis, found in 2005.

Max. h 2.7 cm, max. w 3.3 cm, max. th 0.5 cm.

Red (10R 5/8) slip on exterior and interior, thin paste, non-porous, fine, red (10R 5/6) fabric with some lime inclusions.

Harrison 1991: 224, fig. 6, n° 4.

Late 4<sup>th</sup> or 5<sup>th</sup> cent. A.D.

**pl. 13/229 and pl. 39/229.**

**229.** (N° 980): Rim fragment; from the field surveys in Hadrianopolis, found in 2005.

Max. h 4.3 cm, max. w 5.3 cm, max. th 0.8 cm.

Thin red (10R 5/8) and red (2.5YR 5/6) mottled slip on exterior, red (2.5YR 5/6) slip on interior, average hardness, thin paste, non-porous, fine, reddish yellow (5YR 7/6) fabric with infrequent lime inclusions.

Poblome 1999: 309, Type 1C170, fig. 63, n° 3.

3<sup>rd</sup> cent. A.D.<sup>47</sup>.

**pl. 13/230 and pl. 39/231.**

**230.** (N° 1386): Rim fragment; surface find from Göletarkası, found in 2005.

Max. h 3.7 cm, d of rim 22.0 cm, max. w 5.9 cm, max. th 0.8 cm.

Red (10R 5/8) slip on exterior and interior, very sparsely porous, average hardness, thin paste, fine, reddish yellow (5YR 6/6) fabric with infrequent micaceous inclusions.

Poblome 1999: 309, Type 1C170, fig. 63, n° 3.

3<sup>rd</sup> cent. A.D.

**pl. 13/231 and pl. 39/230.**

**231.** (N° 401): Rim fragment; Kimistene, *Acropolis*, eastern slope, lower terrace, close to the creek, found in 2005.

Max. h 3.3 cm, d of rim 22.8 cm, max. w 6.8 cm, max. th 0.6 cm.

Reddish brown (2.5YR 5/4) slip on exterior and interior, non-porous, thin paste, fine, reddish yellow (5YR 6/6) fabric with some sand inclusions.

Poblome 1999: 309, Type 1C170, fig. 63, n° 1; Kenrick 1985: 344, fig. 64, B604.2.

3<sup>rd</sup> cent. A.D.

**pl. 13/232 and pl. 39/232.**

**232.** (N° 403): Rim fragment; Kimistene, *Acropolis*, eastern slope, lower terrace, close to the creek, found in 2005.

Max. h 4.2 cm, d of rim 25.2 cm, max. w 7.3 cm, max. th 0.7 cm.

Dusky red (2.5YR 3/2) slip on exterior rim, its below part light red (2.5YR 6/8) slip, red (2.5YR 5/6) slip on interior, thin paste, non-porous, fine, yellowish red (5YR 5/6) fabric with no visible inclusions.

Poblome 1999: 309, Type 1C160, fig. 61, n° 6.

3<sup>rd</sup> cent. A.D.

**BOWL FORM 2 (pl. 14)**

Only one example was found in the *Domus*. This rim fragment has a groove on its top. Its lip is thinned. Red slip covers all of its surface. Its fine fabric is red in colour. Rim diameter is 15.6 cm. Similar forms were noted in Sagalassus during the first half of the 5<sup>th</sup> to first half of the 6<sup>th</sup> cent. A.D.<sup>48</sup>.

**pls. 14 and 40.**

**233.** (N° 1486): Rim fragment, *Domus*, found in 2007.

Max. h 1.7 cm, d of rim 15.6 cm, max. w 3.0 cm, max. th 0.5 cm.

Red (10R 5/8) slip on exterior, red (10R 5/6) slip on interior, sparsely porous, hard, thin paste, fine, reddish yellow (5YR 6/6) fabric with no visible inclusions.

Poblome 1999: 306, Type 1B180, fig. 31, n° 5.

First half of the 5<sup>th</sup> cent. A.D.<sup>49</sup>.

**BOWL FORM 3 (pls. 15-17)**

The largest group is represented by 19 examples with minor typological differences. The first example has a broad flange on the exterior of the rim. The others have vertical rims, generally concave on the outer surface, thickened on the outside and has a rounded lip<sup>50</sup>. The wall is flaring, curved or slightly angled.

Similar shapes to n° 235 were discovered at Sagalassus, Perge and Hierapolis and dated to the 6<sup>th</sup> cent. A.D.<sup>51</sup>, whereas Hayes dates similar examples to the second half of the 5<sup>th</sup> and first half of the 6<sup>th</sup> cent. A.D.<sup>52</sup>. In Pompeiopolis, K. Domzalski has determined similar sherds as 'Late Roman C/Phocaeen Red Slip ware' and dated them to the late 5<sup>th</sup>-early 6<sup>th</sup> cent. A.D.<sup>53</sup>. This form is dated at Thasos to the

47) Poblome 1999: 309.

48) Poblome 1999: 306 and 368, fig. 31, n° 5.

49) Poblome 1999: 306.

50) Hayes 1972: 329.

51) Poblome *et al.* 2001: 126, fig. 4, n° 7.

52) Hayes 1972: 337-338.

53) Domzalski 2011: 10, fig. 11, Form 3.

second half of the 5<sup>th</sup> cent.<sup>54</sup>, at Ephesus to the late 5<sup>th</sup> and early 6<sup>th</sup> cent.<sup>55</sup>, and in Amorium to the 5<sup>th</sup> cent. A.D.<sup>56</sup>. Similar forms were discovered at Çerkeş/Kızıllar (Antoninopolis?), Bozoğlu/Çerkeş, Yazı/Ilgaz, and Kuzören/Eskipazar by the team of R. J. Matthews in the course of BIAA's Paphlagonia Project<sup>57</sup>.

Its slip varies in colour between reddish brown and light red and is applied only in a limited area between the inner surface and the rim part of the bowl. Its slip is fine and matt. Its fabric is reddish yellow to red with sand and lime inclusions. Most of them were found at *Domus*. Rim diameters vary from 18.0 to 30.8 cm.

**pl. 15/234 and pl. 41/234.**

**234.** (N° 1483): Rim fragment, *Domus*, found in 2007.

Max. h 2.4 cm, max. w 3.3 cm, max. th 0.6 cm.

Red (10R 5/8) slip on exterior, red (10R 5/8) and light red (2.5YR 6/8) mottled slip on interior, soft, fine, non-porous, thin paste, reddish yellow (5YR 7/6) fabric with some sand and lime inclusions.

Bonifay 2004: 203, type 78, 204, fig. 108, nos. 1-2; Hayes 1972: 144, ARS, Form 91, fig. 26, n° 25; Kenrick 1985: 365, ARS, fig. 67, B 654.4.

First half of the 6<sup>th</sup> cent. A.D.<sup>58</sup>.

**pl. 15/235 and pl. 41/235.**

**235.** (N° 188): Rim fragment; Bath A, Room 4, found in 2006.

Max. h 2.6 cm, d of rim 28.6 cm, max. w 6.1 cm., max. th 0.8 cm.

Red (2.5YR 5/6) slip on exterior and interior, average hardness, very sparsely porous, thin paste, fine, reddish yellow (5YR 6/6) fabric with frequent sand inclusions.

Harrison 1992: 216, fig. 5, n° 19. Hayes 1972: 338, Form 3H, fig. 68; Matthews *et al.* 2009: 218, fig. 6.103, PS 006, nos. 1-3, PS 074, n° 7, PS 115, n° 12.

First half of the 6<sup>th</sup> cent. A.D.<sup>58</sup>.

**pl. 15/236 and pl. 41/236.**

**236.** (N° 11): Rim fragment, *Domus*, Room 1, found in 2007.

Max. h 4.6 cm, d of rim 30.8 cm, max. w 10.4 cm, max. th 0.7 cm.

Weak red (10R 5/4) slip on upper exterior and interior, hard, porous, thin paste, fired to weak red (2.5YR 5/2) fabric with some lime inclusions.

**pl. 15/237 and pl. 41/237.**

**237.** (N° 149): Rim fragment, *Domus*, Room 4, found in 2007.

Max. h 6.2 cm, d of rim 18.0 cm, max. w 7.5 cm, max. th 0.8 cm.

Reddish brown (2.5YR 5/4) slip on exterior, its below part light red (2.5YR 6/6) unslipped surface, red (2.5YR 5/6) slip on interior, hard, non-porous, thin paste, fine, red (2.5YR 5/8) fabric with some lime and sand inclusions.

**pl. 15/238 and pl. 41/238.**

**238.** (N° 114): Rim fragment; *Domus*, Room 6, found in 2007.

Max. h 3.9 cm, d of rim 19.0 cm, max. w 7.3 cm, max. th 0.7 cm.

Thin reddish yellow (7.5YR 6/6) slip on exterior, light brown (7.5YR 6/3) slip on interior, very sparsely porous, average hardness, fired to brown (7.5YR 4/2) fabric with some sand inclusions.

**pl. 15/239 and pl. 41/239.**

**239.** (N° 198): Rim fragment; Bath A, Room 5, found in 2006.

Max. h 4.4 cm, d of rim 21.0 cm, max. w 5.4 cm, max. th 0.8 cm.

Reddish brown (2.5YR 5/4) slip on exterior, its below part light brown (7.5YR 6/3) unslipped surface, reddish brown (2.5YR 4/3) slip on interior, very sparsely porous, hard, thin paste, fired to reddish gray (10R 5/1) fabric with some lime inclusions.

**pl. 16/240 and pl. 41/240.**

**240.** (N° 57): Rim fragment, *Domus*, Room 6, found in 2007.

Max. h 3.3 cm, d of rim 22.0 cm, max. w 7.2 cm, max. th 0.8 cm.

Red (2.5YR 5/6) slip on upper exterior, its below part light red (2.5YR 7/6) unslipped surface, weak red (10R 5/4) slip on interior rim, its below part red (2.5YR 5/6) slip, porous, hard, thin paste, fine, red (2.5YR 5/6) fabric with frequent micaceous inclusions.

**pl. 16/241 and pl. 41/241.**

**241.** (N° 374): Rim fragment; *Domus*, Room 6, found in 2007.

Max. h 4.8 cm, d of rim 23.2 cm, max. w 8.3 cm, max. th 0.7 cm.

Light red (2.5YR 6/6) unslipped on exterior and interior, exterior surface with grog, hard, very sparsely porous, thin paste, fine, light red (2.5YR 6/6) fabric with some lime inclusions.

54) Abadie-Reynal 1992: 19, fig. 3-4, n°s 64-75.

55) Gassner 1997: 143-144, figs. 558-562.

56) Harrison 1992: 216, fig. 5, n° 19.

57) Matthews *et al.* 2009: 218, fig. 6.103, n°s 1-3 from the site PS066, n° 7 from PS074, n° 12 from PS115; fig. 6.104, n°s 4-5 from PS157.

58) Hayes 1972: 338.

**pl. 16/242 and pl. 41/242.**

**242.** (N° 159): Rim fragment; *Domus*, found in 2007. Max. h 6.6 cm, d of rim 23.8 cm, max. w 13.3 cm, max. th 0.9 cm.

Pink (7.5YR 7/4) and reddish yellow (5YR 6/6) unslipped surface on exterior, reddish yellow (5YR 6/6) unslipped surface on interior, hard, non-porous, thin paste, fine, reddish yellow (5YR 6/6) fabric with some sand and lime inclusions.

**pl. 16/243 and pl. 42/243.**

**243.** (N° 148): Rim fragment, *Domus*, Room 4, found in 2007.

Max. h 5.6 cm, d of rim 23.8 cm, max. w 8.5 cm, max. th 0.8 cm.

Reddish brown (2.5YR 5/4) slip on exterior and interior, hard, non-porous, fine, red (2.5YR 5/6) fabric with some sand and lime inclusions.

First half of the 6<sup>th</sup> cent. A.D.

**pl. 16/244 and pl. 42/244.**

**244.** (N° 234): Rim fragment; Bath A, Room 7, found in 2006.

Max. h 2.6 cm, d of rim 24.4 cm, max. w 5.7 cm, max. th 0.6 cm.

Red (2.5YR 5/6) slip on exterior rim, its below part light reddish brown (2.5YR 6/4) unslipped surface, porous surface on exterior and interior, red (2.5YR 5/6) slip on interior, hard, thin paste, non-porous, fired to brown (7.5YR 5/3) fabric with infrequent sand and lime inclusions.

**pl. 17/245 and pl. 42/245.**

**245.** (N° 232): Rim fragment, Bath A, Room 13, found in 2006.

Max. h 5.4 cm, d of rim 24.6 cm, max. w 10.0 cm, max. th 0.7 cm.

Reddish brown (2.5Yr 5/4) slip on exterior and interior, hard, thin paste, non-porous, fired to dark gray (5YR 5/1) fabric with some lime and occasional sand inclusions.

**pl. 17/246 and pl. 42/246.**

**246.** (N° 49): Rim fragment, *Domus*, Room 6, found in 2007.

Max. h 4.4 cm, d of rim 24.8 cm, max. w 9.9 cm, max. th 0.8 cm.

Weak red (10R 5/4) slip on upper exterior, its below part pink (5YR 7/4) unslipped surface, reddish yellow (5YR 6/8) slip on interior rim, its below part red (10R 5/6) unslipped surface, hard, very sparsely porous, fine, yellowish red (5YR 5/6) fabric with some sand and occasional lime inclusions.

**pl. 17/247 and pl. 42/247.**

**247.** (N° 1385): Rim fragment; surface find from Göletarkası, found in 2005.

Max. h 3.8 cm, d of rim 24.8 cm, max. w 11.3 cm, max. th 0.9 cm.

Reddish brown (2.5YR 4/4) slip on exterior and interior, hard, thin paste, non-porous, fired to red (2.5YR 4/4) fabric with some sand inclusions.

**pl. 17/248 and pl. 42/248.**

**248.** (N° 256): Rim fragment; Western Tomb, found in 2007.

Max. h 2.7 cm, d of rim 24.8 cm, max. w 7.9 cm, max. th 0.8 cm.

Red (2.5YR 5/6) slip on exterior, light red (2.5YR 6/6) slip on interior, thin paste, non-porous, average hardness, fine, red (2.5YR 5/6) fabric with no visible inclusions.

Abadie-Reynal 1992: 23, fig. 7, CF 106; Hayes 1972: 338, Form 3H, fig. 68.

**pl. 17/249 and pl. 42/249.**

**249.** (N° 1464): Rim fragment; Bath A, Room 10b, found in 2007.

Max. h 4.4 cm, d of rim 26.4 cm, max. w 5.9 cm, max. th 0.6 cm.

Weak red (10R 5/4) slip on exterior and interior, thin paste, non-porous, hard, fired to reddish yellow (5YR 6/6) fabric with some sand and lime inclusions.

**pl. 17/250 and pl. 42/250.**

**250.** (N° 225): Rim fragment; Bath A, Room 13, found in 2006.

Max. h 3.3 cm, d of rim 26.6 cm, max. w 7.8 cm, max. th 0.7 cm.

Light red (2.5YR 6/6) slip on exterior, red (10R 6/8) slip on interior, thin paste, non-porous, average hardness, fine, light red (2.5YR 6/8) fabric with infrequent sand inclusions.

**pl. 17/251 and pl. 42/251.**

**251.** (N° 163): Rim fragment; *Domus*, found in 2007.

Max. h 3.6 cm, d of rim 27.0 cm, max. w 5.9 cm, max. th 0.6 cm.

Reddish brown (2.5YR 5/4) slip on exterior, reddish brown (5YR 5/3) slip on interior, hard, porous, fired to reddish brown (5YR 4/3) fabric with frequent sand and lime inclusions.

**pl. 42/252.**

**252.** (N° 166): Rim fragment; *Domus*, found in 2007. Max. h 4.1 cm, max. w 5.3 cm, max. th 0.7 cm.

Light red (2.5YR 6/6) slip on exterior and interior, hard, thin paste, non-porous, fine, light red (2.5YR 6/6) fabric with some lime, chamotte, very little micaceous inclusions.

**BOWL FORM 4** (pls. 18-19)

This form may be a variation of carinated bowls. It is definitely not a homogenous type. Generally its walls have a complex profile. Most have had a large diameter. Sometimes the bowls with horizontal rim have a groove on the upper exterior similar to n<sup>os</sup> 253 and 254 which were found in the Western Tomb. N<sup>o</sup> 256 has an inverted rim and its lip is cut on the exterior.

Fragments of a bowl form with vertical curved rim come from the Agora deposits in Athens and are dated to the late 4<sup>th</sup>-early 5<sup>th</sup> cent. A.D. by Hayes<sup>59</sup>.

**pl. 18/253 and pl. 43/253.**

**253.** (N<sup>o</sup> 1465): Rim fragment; Northwestern Tomb, found in 2007.

Max. h 2.4 cm, d of rim 10.2 cm, max. w 4.1 cm, max. th 0.6 cm.

Red (10R 5/6) slip on exterior and interior, hard, non-porous, fine, light red (2.5YR 6/6) fabric with some lime and sand inclusions.

Poblome 1999: 305, Type 1B140, fig. 23, n<sup>o</sup> 5.

**pl. 18/254 and pl. 43/255.**

**254.** (N<sup>o</sup> 1466): Rim fragment; Western Tomb, found in 2007.

Max. h 3.9 cm, d of rim 16.4 cm, max. w 6.7 cm, max. th 0.8 cm.

Red (10R 5/8) slip on exterior, red (10R 5/6) slip on interior, hard, non-porous, thin paste, fine, red (10R 5/8) fabric with rare tiny lime inclusions.

Poblome 1999: 305, Type 1B140, fig. 23, n<sup>o</sup> 5.

**pl. 18/255 and pl. 43/254.**

**255.** (N<sup>o</sup> 26): Rim fragment; *Domus*, Room 1, found in 2007.

Max. h 3.1 cm, d of rim 18.2 cm, max. w 4.4 cm, max. th 0.7 cm.

Weak red (2.5YR 4/2) slip on upper exterior, weak red (2.5YR 5/2) unslipped surface, reddish brown (2.5YR 5/3) slip on interior, hard, very sparsely porous, thin paste, fine, red (2.5YR 5/6) fabric with infrequent lime inclusions.

Hayes 1972: 327, LRC, form 1A, fig. 65, n<sup>o</sup> 1 and Zelle 2003: LRC, fig. 5, n<sup>os</sup> 1-3.

Late 4<sup>th</sup>-early 5<sup>th</sup> cent. A.D.<sup>60</sup>.

**pl. 18/256 and pl. 43/256.**

**256.** (N<sup>o</sup> 152): Rim fragment; *Domus*, found in 2007.

Max. h 4.7 cm, d of rim 19.4 cm, max. w 9.5 cm, max. th 0.7 cm.

Thin, matt red (10R 5/6) slip on exterior and interior, hard, non-porous, fired to red (2.5YR 5/6) fabric with rare tiny lime inclusions.

Poblome 1999: 306, type 1B170, fig. 29, n<sup>o</sup> 9.

59) Hayes 1972: 325, LRC, Form 1A, fig. 65.

60) Hayes 1972: 327.

**pl. 18/257 and pl. 43/257.**

**257.** (N<sup>o</sup> 187): Rim fragment; Bath A, Room 4, found in 2007.

Max. h 4.5 cm, d of rim 23.0 cm, max. w 8.0 cm, max. th 0.6 cm.

Thin, matt red (10R 5/8) slip on exterior, light red (2.5YR 6/6) slip on interior, hard, non-porous, thin paste, fine, light red (2.5YR 6/8) fabric with no visible inclusions.

**pl. 18/258 and pl. 43/258.**

**258.** (N<sup>o</sup> 41): Rim fragment; *Domus*, Room 6, found in 2007.

Max. h 2.7 cm, d of rim 25.6 cm, max. w 6.7 cm, max. th 0.6 cm.

Matt reddish yellow (5YR 6/6) slip on exterior, light red (2.5YR 6/6) slip on interior, hard, very sparsely porous, thin paste, fine, red (2.5YR 5/6) fabric with rare lime inclusions.

**pl. 19/259 and pl. 43/259.**

**259.** (N<sup>o</sup> 139): Rim fragment; *Domus*, Room 4, found in 2007.

Max. h 6.2 cm, d of rim 25.6 cm, max. w 9.2 cm, max. th 0.8 cm.

Thin red (10R 5/6) slip on upper exterior and interior, hard, thin paste, non-porous, light reddish brown (5YR 6/4) fabric with some sand and lime inclusions.

**pl. 19/260 and pl. 43/260.**

**260.** (N<sup>o</sup> 146): Rim fragment; *Domus*, Room 4, found in 2007.

Max. h 3.9 cm, d of rim 26.0 cm, max. w 7.9 cm, max. th 0.8 cm.

Thin, matt light red (2.5YR 6/6) slip on exterior, pink (5YR 7/4) slip on interior, hard, thin paste, non-porous, fine, red (2.5YR 5/6) fabric with some sand and infrequent micaceous inclusions.

**pl. 19/261 and pl. 43/261.**

**261.** (N<sup>o</sup> 145): Rim fragment; *Domus*, Room 4, found in 2007.

Max. h 4.7 cm, d of rim 27.6 cm, max. w 9.3 cm, max. th 0.9 cm.

Red (2.5YR 5/6) slip on upper exterior, light red (2.5YR 6/6) slip on interior, non-porous, average hardness, fine, reddish brown (5YR 5/4) fabric with some sand and lime inclusions.

**pl. 19/262 and pl. 43/262.**

**262.** (N<sup>o</sup> 1389): Rim fragment; surface find from Göletarkası, found in 2005.

Max. h 4.1 cm, d of rim 27.4 cm, max. w 7.0 cm, max. th 0.8 cm.

Thin red (10R 5/6) slip on upper exterior, light red (2.5YR 6/6) slip on interior, hard, thin paste, very sparsely

porous, fired to reddish brown (5YR 5/4) fabric with some lime inclusions.

#### **DISH** (pl. 20)

We have only one dish fragment belonging to this form. The everted and rounded rim has a painted dark reddish to brown band on its interior surface. This form was popular in the second half of the 1<sup>st</sup> cent. A.D.<sup>61</sup>; but in Sagalassus it is common until the 3<sup>rd</sup> cent. A.D. In Aizanoi it is known in the 3<sup>rd</sup>-4<sup>th</sup> cent. A.D.<sup>62</sup>.

#### **pls. 20 and 44.**

**263.** (N° 260): Rim fragment; Western Tomb, found in 2007.

Max. h 1.9 cm, d of rim 24.0 cm, max. w 9.1 cm, max. th 0.7 cm.

Reddish yellow (5YR 6/6) and brown (7.5YR 5/4) mottled slip on exterior, light yellowish brown (2.5Y 6/3) slip all of interior and its between dark reddish brown (5YR 3/2) band slip on rim, thin paste, non-porous, average hardness, fine, reddish yellow (5YR 6/6) fabric with rare lime inclusions.

Poblome 1999: 308, Variant 1C 132, fig. 56, n° 2.

Second half of 1<sup>st</sup> cent. until the 3<sup>rd</sup> cent. A.D.

#### **BASE FRAGMENTS OF OPEN FORMS** (pl. 21)

These base fragments have a curved floor. N° 264 has a stamped decoration on its floor and a tapering foot which resembling to Hayes' Late Roman C, form 1A, dated to the late 4<sup>th</sup> and early 5<sup>th</sup> cent. A.D.<sup>63</sup>.

#### **pl. 21/264 and pl. 45/264.**

**264.** (N° 186): Base fragment; Bath A, Room 6a-c, found in 2006.

Decorated patterns in a medallion in its tondo. Possibly a plate.

Max. h 2.0 cm, d of base 14.0 cm, max. w 5.8 cm, max. th 1.0 cm.

Red (2.5YR 5/8) slip on exterior and interior, thin paste, non-porous, hard, fine, light red (2.5YR 6/8) fabric with some micaceous inclusions.

#### **pl. 45/265.**

**265.** (N° 1400): Base fragment; from the field surveys in Hadrianopolis, found in 2005.

Possibly a plate.

Max. h 1.8 cm, max. w 4.5 cm, max. th 0.8 cm.

Pink (7.5YR 7/4) unslipped on exterior, rough surface on exterior foot, red (2.5YR 5/8) slip on interior, thin paste, non-porous, hard, fired to red (2.5YR 5/8) fabric with frequent lime inclusions.

61) Poblome 1999: 308, variant 1C132, fig. 56.

62) Ateş 2003: 150, Teller 12, pl. 44, n° 246.

63) Hayes 1972: 327, fig. 65.

#### **pl. 45/266.**

**266.** (N° 1484): Base fragment, restored with n° 267; surface find from the village Boncuklar, found in 2005.

Max. h 1.4 cm, max. w 4.1 cm, max. th 0.4 cm.

Reddish brown (2.5YR 4/4) and dusky red (2.5YR 3/2) mottled slip on exterior, red (2.5YR 5/8) slip on interior, thin paste, non-porous, average hardness, red (10R 5/6) fabric with infrequent sand inclusions.

#### **pl. 45/267.**

**267.** (N° 1493): Base fragment, restored with n° 266; surface find from the village Boncuklar, found in 2005.

Max. h 1.6 cm, max. w 3.3 cm, max. th 0.4 cm.

Reddish brown (2.5YR 4/4) and dusky red (2.5YR 3/2) mottled slip on exterior, red (2.5YR 5/8) slip on interior, thin paste, non-porous, average hardness, red (10R 5/6) fabric with infrequent sand inclusions.

#### **BODY FRAGMENTS OF OPEN FORMS** (pl. 46)

Since most of the body of the red-slipped samples is non-slipped, it is very probable that they were not collected during the excavations and surveys. Therefore, this group of body fragments contains only sherds with slip.

#### **pl. 46/268.**

**268.** (N° 185): Body fragment; Bath A, Room 6a-c, found in 2006.

Two pieces.

Max. h 4.1 cm, max. w 8.2 cm, max. th 0.8 cm.

Red (2.5YR 5/6) slip on exterior, reddish brown (5YR 5/4) slip on interior, thin paste, hard, very sparsely porous, fired to light reddish brown (5YR 6/4) fabric with infrequent lime inclusions.

#### **pl. 46/269.**

**269.** (N° 308): Body fragment; Kimistene Acropolis, southern slope, found in 2005.

Max. h 2.6 cm, max. w 2.7 cm, max. th 0.5 cm.

Red (10R 5/8) thin slip on exterior and interior, thin paste, hard, very sparsely porous, fine, reddish yellow (5YR 6/6) fabric with some lime inclusions.

#### **CLOSED FORMS** (pl. 22)

It seems that red-slipped wares in closed forms are very few in numbers, perhaps due to the rising utilization of glass as table ware.

#### **JUG/SMALL POT?** (pl. 22)

Fragment of a small thin walled vessel with a squat neck and bulgy body.

**pl. 22 and 47.**

**270.** (N° 402): Rim fragment; Kimistene Acropolis, eastern slope, the lower temple slope, close to the creek, found in 2005.

Handle (d 3 cm) is missing.

Max. h 3.1 cm, d of rim 13.0 cm, max. w 4.8 cm, max. th 0.5 cm.

Red (2.5YR 5/8) slip on exterior and interior, thin paste, hard, non-porous, fine reddish yellow (5YR 6/6) fabric with frequent tiny lime inclusions.

### **BODY FRAGMENTS OF CLOSED FORMS (pl. 48)**

**pl. 48/271.**

**271.** (N° 1451): Body fragment; from an unknown location.

Thick wall. Must belong to a huge closed form with a belly. Two rows of dots as decoration pattern on its exterior side. It can also be classified as sigillata because of its shiny exterior surface.

Max. h 5.1 cm, max. w 5.2 cm, max. th 0.8 cm.

Shiny red (2.5YR 4/8) slip on exterior, smoothed surface on exterior, light red (2.5YR 7/8) unslipped surface on interior, thin paste, hard, non-porous, fine light red (2.5YR 6/8) fabric with tiny lime inclusions.

**pl. 48/272.**

**272.** (N° 648): Body fragment; Kimistene Acropolis, western slope, found in 2005.

Max. h 2.3 cm, max. w 2.3 cm, max. th 0.5 cm.

Red (10R 5/8) slip on exterior, pink (5YR 7/4) unslipped surface on interior, thin paste, average hardness, non-porous, fine, reddish yellow (5YR 6/6) fabric with infrequent lime and sand inclusions.

### **LAMP FRAGMENT IN RED-SLIP TRADITION (pl. 49)**

Only one sherd from *Domus* with carbon traces.

**pl. 49.**

**273.** (N° 28): Shoulder fragment; *Domus*, Room 1, found in 2007.

Burned heavily.

Max. h 2.1 cm, max. w 4.4 cm, max. th 0.6 cm.

Very dark gray (5YR 3/1) surface on exterior, reddish yellow (7.5YR 6/6) surface on interior, thin paste, average hardness, non-porous, fine, dark gray (7.5YR 4/1) fabric with no visible inclusions.

**CONCLUSIONS**

Most of the local sigillata described above have a hard, homogenous fabric and contain some visible inclusions. Some sherds have technical defects. The typology of the local sigillata and red-slipped ware resembles that of the western and southern Anatolian workshops.

In Bath A a large number of very small sigillata sherds was found; they were perhaps deposited in the debris of the Bath. Because of the number of Early Roman sigillata fragments deposited, it is definite that Bath A was in an area close to the Roman cemetery yard where numerous Early Roman burials should be expected. It is however strange that the location of Bath A was a Roman burial area, because of its central location in the city. One wonders where the Roman city's nucleus was.

The frequency of fineware in the temple area of Kimistene shows that the area was a religious area since, at the latest, the Late Phrygian Era and sigillata had a religious function. Since we have no evidence of terracotta figurines or lamps from Kimistene's Acropolis, it is interesting to see how frequent sigillata is. Both of the main survey areas, i.e. Hadrianopolis and Kimistene, are similar with respect to sigillata and red-slipped traditions, but Kimistene has very few later ceramics after the 4<sup>th</sup> cent. A.D. 4<sup>th</sup> cent. A.D. is also the date of the abandonment of the pagan temple at Kimistene.

The amount of terra sigillata at Hadrianopolis and its surrounding area is not large. It seems that sigillata in this landscape was associated with local demands, especially with use of burial gifts. In this case sigillata in southwestern Paphlagonia cannot be interpreted as a 'commercial good'. Sigillata was part of the urban pottery tradition in Roman Asia Minor from the 1<sup>st</sup> cent. A.D. onwards, but the function of sigillata in southwestern Paphlagonia was different: in this part of Asia Minor sigillata was mostly used as burial goods. It is very probable that during the 1<sup>st</sup> cent. B.C. to the 2<sup>nd</sup> cent. A.D. sigillata was popular in southwestern Paphlagonia as grave gifts, while later on – after the 3<sup>rd</sup> cent. A.D. – red-slipped began to be used as table ware. Further evidence for the common use of local sigillata as burial gifts has been provided by the surveys of G. Karauğuz in Devrek, Gökçebey, Çaycuma, and Çaydeğirmeni in the Province of Zonguldak<sup>64</sup>. Also a juglet with three fragments (Fig. 2a-c) collected by J. Mellaart in the area and today stored in the

64) Karauğuz 2006: 327.

Sherd Collection of the British Institute of Archaeology at Ankara shows that local sigillata from Hadrianopolis can be found as far west as Mengen. It is possible that Greek and Roman food culture was not introduced into southwestern Paphlagonia before the beginning of the red-slipped ware tradition and the wood was an important material for the crockery.

The sigillata finds indicate regional production in southwestern Paphlagonia, northwestern Galatia,

and eastern Bithynia. The location of this workshop should be somewhere between Gangra and Hadrianopolis<sup>65</sup>, most probably in the *chora* of Hadrianopolis, where there was a constant water supply and suitable clay. More work is required in the study of modern production centres, such as Çömlekçiler Village of Eskipazar, to understand ancient kiln sites.

E.L. and G.K.Ş.

65) There is a Roman workshop and its potters quarter in Polatlı, ca. 80 km west of Ankara where there is no known Roman city. We do not know where this unknown workshop was serving.

## ABBREVIATIONS AND REFERENCES

- Abadie-Reynal, C., 1992 : "Les céramiques fines", in C. Abadie-Reynal and J.-P. Sodini, *La céramique paléochrétienne de Thasos (Alikí, Delkos, fouilles anciennes)*, Ecole française d'Athènes, Etudes Thasiennes, XIII, Paris / Athens : 13-35 and fig. 1-14.
- Ateş, G., 2003 : *Die rote Feinkeramik von Aizanoi als lokaler Kulturträger* (Untersuchungen zum Verhältnis von lokaler roter Glanztonware und importierter Sigillata) (unpubl. diss. ; University of Heidelberg).
- Bonifay, M., 2004 : *Etudes sur la céramique romaine tardive d'Afrique*, British Archaeological Reports, International Series 1301, Oxford.
- Devreker, J., Thoen/Vermeulen, F. et al. 2003 : *Excavations in Pessinus : the So-called Acropolis. From Hellenistic and Roman Cemetery to Byzantine Castle*, Ghent University, Archaeological Reports 1, Ghent.
- Domzalski, K., 2011 : *Late Roman Pottery from Pompeiopolis*, in <<http://www.klass-archaeologie.uni-muenchen.de/projekte/pompeiopolis/projekt/materialstudien/spaetroemkeramik.pdf>> (15/12/2011).
- Ettlinger, E., Hedinger, B., Hoffmann, B., Kenrick, P.M., Pucci, G., Roth-Rubi, K., Schneider, G., von Schnurbein, S., Wells, S.M., Zabehlicky-Scheffenecker, S. et al. 1990 : *Conspectus formarum terrae sigillatae Italico modo confectae*, Materialien zur römisch-germanischen Keramik 10, Bonn.
- Firat, N., 2010 : "Les céramiques sigillées mises au jour dans l'atelier de Demirci", in D. Kassab Tezgör (ed.), *Les fouilles et le matériel de l'atelier amphorique de Demirci près de Sinope*, Varia Anatolica 22, İstanbul / Paris : 187-195 and pls. 49-54.
- Gassner, V., 1997 : *Das Südtor der Tetragonos-Agora, Keramik und Kleinfunde*, Österreichische Akademie der Wissenschaften, Forschungen in Ephesos 13: 1/1, Vienna.
- Gunneweg, J., Perlman, I., Yellin, J. et al. 1983 : *The Provenience, Typology and Chronology of the Eastern Terra Sigillata*, The Hebrew University of Jerusalem, QEDem, Monographs of the Institute of Archaeology 17, Jerusalem.
- Harrison, R.M., 1991 : "Amorium Excavations 1990 : The Third Preliminary Report", *Anatolian Studies* 41 : 215-229.
- Hayes, J.W., 1972 : *Late Roman Pottery*, London.
- 1985 : "Sigillate orientali", in R. Bianchi Bandinelli and G. Becatti (eds.), *Enciclopedia dell'arte antica classica e orientale. Atlante delle forme ceramiche*, II, *Ceramica fine Romana nell'basino Mediterraneo (tardoellenismo e primo impero)*, Rome : 1-96.
- 1991 : *Paphos 3: The Hellenistic and Roman Pottery*, Nicosia.
- 2008 : *The Athenian Agora 32: Roman Pottery. Fine-ware Imports*, Princeton, N.J.
- 1992 : "Amorium Excavations 1991 : The Fourth Preliminary Report", *Anatolian Studies* 42 : 207-222.
- Henrickson, R.C., 1992 : "Politics, Economics and Ceramic Continuity at Gordion in the Late Second and First Millennia B.C.", in W. D. Kingery (ed.), *Social and Cultural Context of New Ceramic Technologies*, Westerville, OH : 89-176.
- Karağuz, G., 2006 : "2005 Yılı Devrek-Gökçebeğ (Tefen) Yüzeý Arařtırması", in *AST* 24, Ankara : 327-340.
- Kaya, N., 2003 : "Ankara Ulus Kazısında Ele Geçen Baskılı Kaplar", in C. Abadie-Reynal (ed.), *Les céramiques en Anatolie aux époques hellénistique et romaine, Actes de la table ronde d'Istanbul, 23-24 mai 1996*, Institut français d'études anatoliennes, Georges Dumézil, Varia Anatolica 15, Paris : 111-116 and pls. 72-73.
- Kenrick, P.M., 1985 : *Excavations at Sidi Khrebish Benghazi (Berenike)*, Vol. III, Part 1: *The Fine Pottery*, Supplements to the Libya Antiqua V, Tripoli.
- Knipowitsch, T.P., 1929 : *Untersuchungen zur Keramik römischer Zeit aus den griechischen Städten an der Nordküste des Schwarzes Meeres I. Die Keramik römischer Zeit aus Olbia in der Sammlung der Ermitage*, Materialien zur römisch-germanischen Keramik IV, Frankfurt.
- Laflı, E., 2003 : "Neue Erkenntnisse zur lokalen Keramik aus Tavium", in K. Strobel and C. Gerber, "Tavium (Büyüknemes, Provinz Yozgat)-Bericht über die Kampagnen 2000-2002", *Istanbul Mitteilungen* 53 : 153-157.
- 2006 : "Hellenistic and Roman Ceramic Archaeology on the Southern Black Sea Coast: An Overview of the Turkish Archaeological Literature related to Ceramic Archaeology of Paphlagonia and Pontus", in B. D. Erciyas and E. Koprıman (eds.), *Karadeniz Arařtırmaları Sempozyum Bildirileri/Black Sea Studies Symposium Proceedings, 2004 Ankara*, İstanbul : 189-202.
- 2009a : "Paphlagonia Hadrianopolis'i Arkeolojik Kazıları ve Onarım Çalışmaları 2008 Yılı Çalışma Raporu", *Arkeoloji ve Sanat* 31/131 : 39-62.
- 2009b : "Glass from Hadrianopolis (Paphlagonia)", in E. Laflı (ed.), *Late Antique/Early Byzantine Glass in the Eastern Mediterranean*, İzmir : 161-170.
- Laflı, E. and Christof, E., 2011a : "Der kaiserzeitliche Tempel von Asartepe/Kimistene in der Chora des paphlagonischen Hadrianopolis - Ergebnisse der Prospektion von 2005", *Istanbul Mitteilungen* 61 : 233-286.
- 2011b : *Hadrianopolis I : Inschriften aus Paphlagonia*, BAR Int. Ser., Oxford (in print).
- Laflı, E. and Kan Şahin, G., 2010 : "Hadrianopolis ve Çevresinden Geç Ortaçağ Sırlı Seramik Örnekleri", in K. Pektaş et al. (eds.), *Proceedings of the XIII<sup>th</sup> Symposium of Medieval and Turkish Period Excavations and Art Historical Researches, 14-16 October 2009*, İstanbul : 427-432.

– in print a : “Pottery from southwestern Paphlagonia I: Terra Sigillata and Red-Slipped Ware”, in B. Ramminger and O. Stilborg (eds.), *Naturwissenschaftliche Analysen vor- und frühgeschichtlicher Keramik II*, Dritter und vierter internationaler Workshop für junge Wissenschaftlerinnen und Wissenschaftler in Hamburg am 9. Februar 2010 und 7. Februar 2011, Universitätsforschungen zur prähistorischen Archäologie aus der Abteilung Vor- und Frühgeschichtliche Archäologie der Universität Hamburg.

– in print b : “A Preliminary Report on the Iron Age and Hellenistic Ceramics from Southwestern Paphlagonia”, in S. Drougou *et al.* (eds.), *H’ Επιστημονική Συνάντηση για την Ελληνιστική Κεραμική (Ιωάννινα 2009) / H’ Scientific Meeting on Hellenistic Pottery, Ioannina 2009. Proceedings*, Athens.

Laflı, E. and Zäh, A., 2008 : “Archäologische Forschungen im byzantinischen Hadrianupolis in Paphlagonien”, *Byzantinische Zeitschrift* 101, Heft 2 : 681-714 and pls. XIII-XXVI.

– 2009 : “Beiträge zur frühbyzantinischen Profanarchitektur aus Hadrianupolis-Blütezeit unter Kaiser Iustinian I.”, *Byzantinische Zeitschrift* 102, Heft 2 : 639-659 and pls. V-XIII.

Matthews, R., Metcalfe, M. and Cottica, D. *et al.* 2009 : “Landscapes with Figures: Paphlagonia through the Hellenistic, Roman and Byzantine Periods, 330 AD-AD 1453”, in R. Matthews and C. Glatz (eds.), *At Empires’ Edge: Project Paphlagonia. Survey in North-Central Turkey*, British Institute of Archaeology at Ankara, Monograph 44, London : 182-186.

Meyer-Schlichtmann, C., 1988 : *Die pergamenische Sigillata aus der Stadtgrabung von Pergamon*, Deutsches Archäologisches Institut, Pergamenische Forschungen 6, Mainz.

Mitchell, S., 1993 : *Anatolia: Land, Men, and Gods in Asia Minor*. Vol. 1 : *The Celts in Anatolia and the Impact of Roman Rule*; Vol. 2 : *The Rise of the Church*, Oxford.

Mitsopoulos-Leon, V., 1991 : *Die Basilika am Staatsmarkt in Ephesos, Kleinfunde*. I. Teil : *Keramik hellenistischer und römischer Zeit*, Österreichisches Archäologisches Institut, FiE 9 : 2/2, Vienna.

Paz, J.V. and Vargas, E.G., 2011 : “Sigillatas africanas y orientales de mediados del VI d. C. procedentes de los rellenos de colmatación de una cisterna de *Hispalis* (Sevilla). Los contextos de la Plaza de la Pescadería”, in M. A. Cau, P. Reynolds and M. Bonifay (eds.), *LRFW 1. Late Roman Fine Wares. Solving Problems of Typology and Chronology. A Review of the Evidence, Debate and*

*New Contexts. Roman and Late Antique Mediterranean Pottery 1*, Oxford : 87-97.

Poblome J., 1999 : *Sagalassos Red Slip Ware, Typology and Chronology*, Studies in Eastern Mediterranean Archaeology 2, Brepols.

Poblome, J., Patrick, D., Cottica, D. and Nalan, F., 2001 : “A New Early Byzantine Production Centre in Western Asia Minor. A Petrographical and Geochemical Study of Red Slip Ware from Hierapolis, Perge and Sagalassos”, *Rei Cretariae Romanae Favtorum, Acta* 37 : 119-126.

Poblome, J. and Firat, N., 2011 : “Late Roman D. A Matter of Open(ing) or Closed Horizons ?”, in M. A. Cau, P. Reynolds and M. Bonifay (eds.), *LRFW 1. Late Roman Fine Wares. Solving Problems of Typology and Chronology. A Review of the Evidence, Debate and New Contexts. Roman and Late Antique Mediterranean Pottery 1*, Oxford : 49-55.

Robinson, H.S., 1959 : *The Athenian Agora 5: Pottery of the Roman Period. Chronology*, Princeton, N.J.

Slane, K.W., 1997 : “The Fine Wares”, in A. Berlin and K. W. Slane, *Tel Anafa II*, i : *The Hellenistic and Roman Pottery*, Journal of Roman Archaeology, Supplementary Series 10, II, i, Ann Arbor, MI : 247-406.

Weber-Hiden, I., 2003 : “Keramik aus hellenistischer bis frühbyzantinischer Zeit aus Tavium/Büyük Nefes: Bemerkungen und Übersicht über das Begehungsmaterial der Kampagnen 1998-2000 aus drei ausgewählten Bereichen des Stadtgebietes”, *Anatolia Antiqua* XI : 253-322.

Williams, C., 1989 : *Anemurium. The Roman and Early Byzantine Pottery*, Pontifical Institute of Mediaeval Studies, Subsidia Mediaevalia 16, Toronto, ON.

Zelle, M., 2003 : “Funde spätantiker Sigillata in Assos”, in B. Liesen and U. Brandl (eds.), *Römische Keramik Herstellung und Handel, Kolloquium Xanten, 15-17.6.2000*, Xantener Berichte 13, Mainz 2003 : 77-106.

Zhuravlev, D., 2002 : “Terra Sigillata and Red Slip Pottery in the Northern Pontic Region (a Short Bibliographical Survey)”, *Ancient Civilizations from Scythia to Siberia* 8 : 237-309.

– 2009 : “Pontic Sigillata Plates with a Vertical Rim from the Belbek IV Necropolis in the South-Western Crimea”, *Ancient Civilizations from Scythia to Siberia* 15 : 25-94.

– 2011 : *Early Roman Fine Ware from Pompeiopolis*, in <<http://www.klass-archaeologie.uni-muenchen.de/projekte/pompeiopolis/projekt/materialstudien/fruehroemkeramik.pdf>> (15/12/2011).

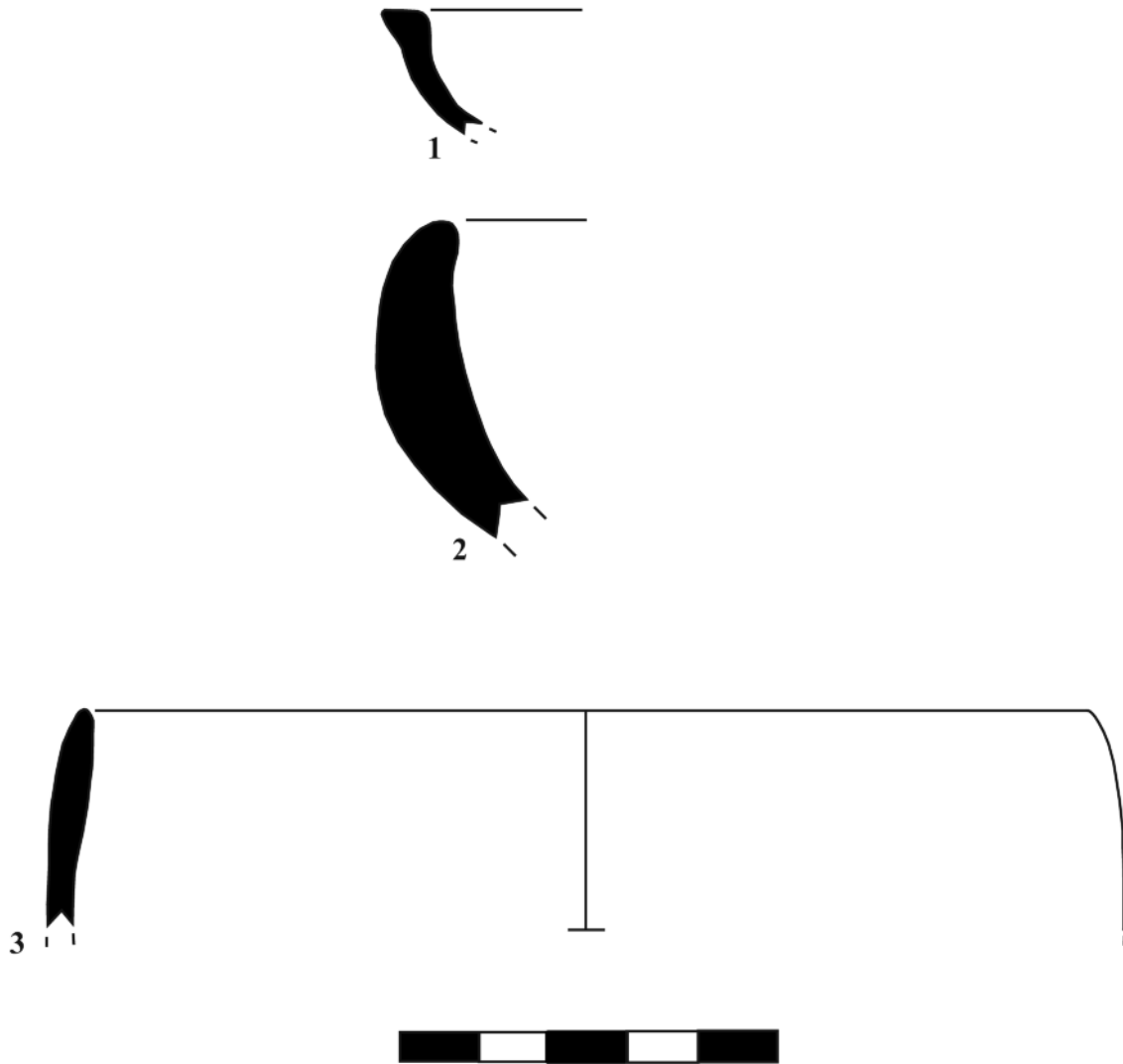

**Pl. 1 : N<sup>os</sup> 1-3 – Imported terra sigillata sherds;  
n<sup>o</sup> 1 – ESA bowl fragment; n<sup>o</sup> 2 – ESA dish fragment; n<sup>o</sup> 3 – ESA bowl fragment.**

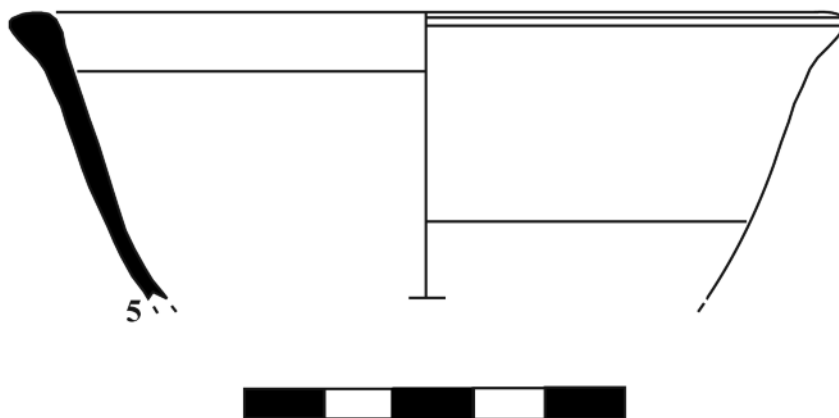

**Pl. 2 : N<sup>o</sup> 5 – Local sigillata, a cup fragment.**

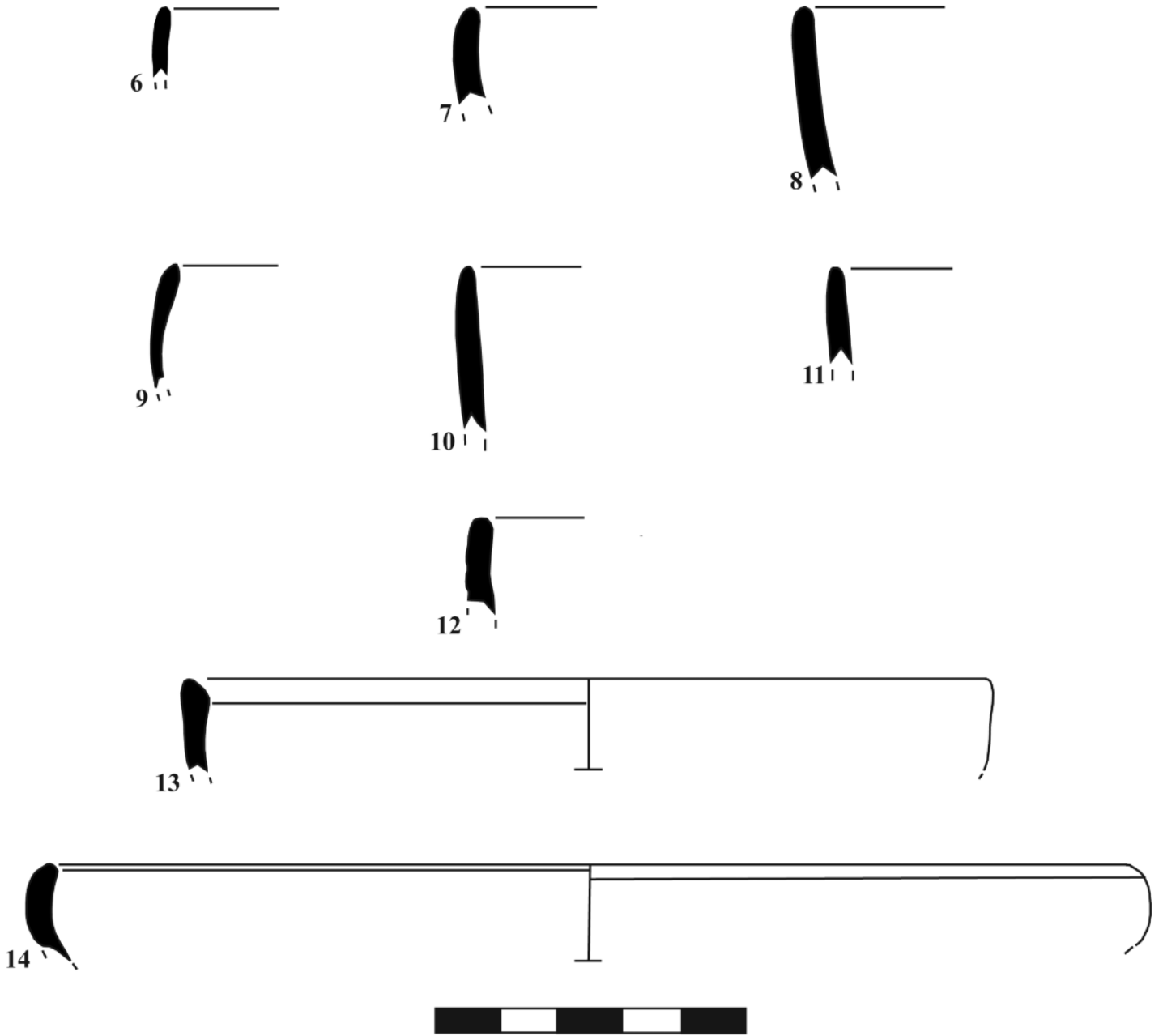

Pl. 3 : N<sup>os</sup> 6-14 – Local sigillata, fragments of bowl form 1.

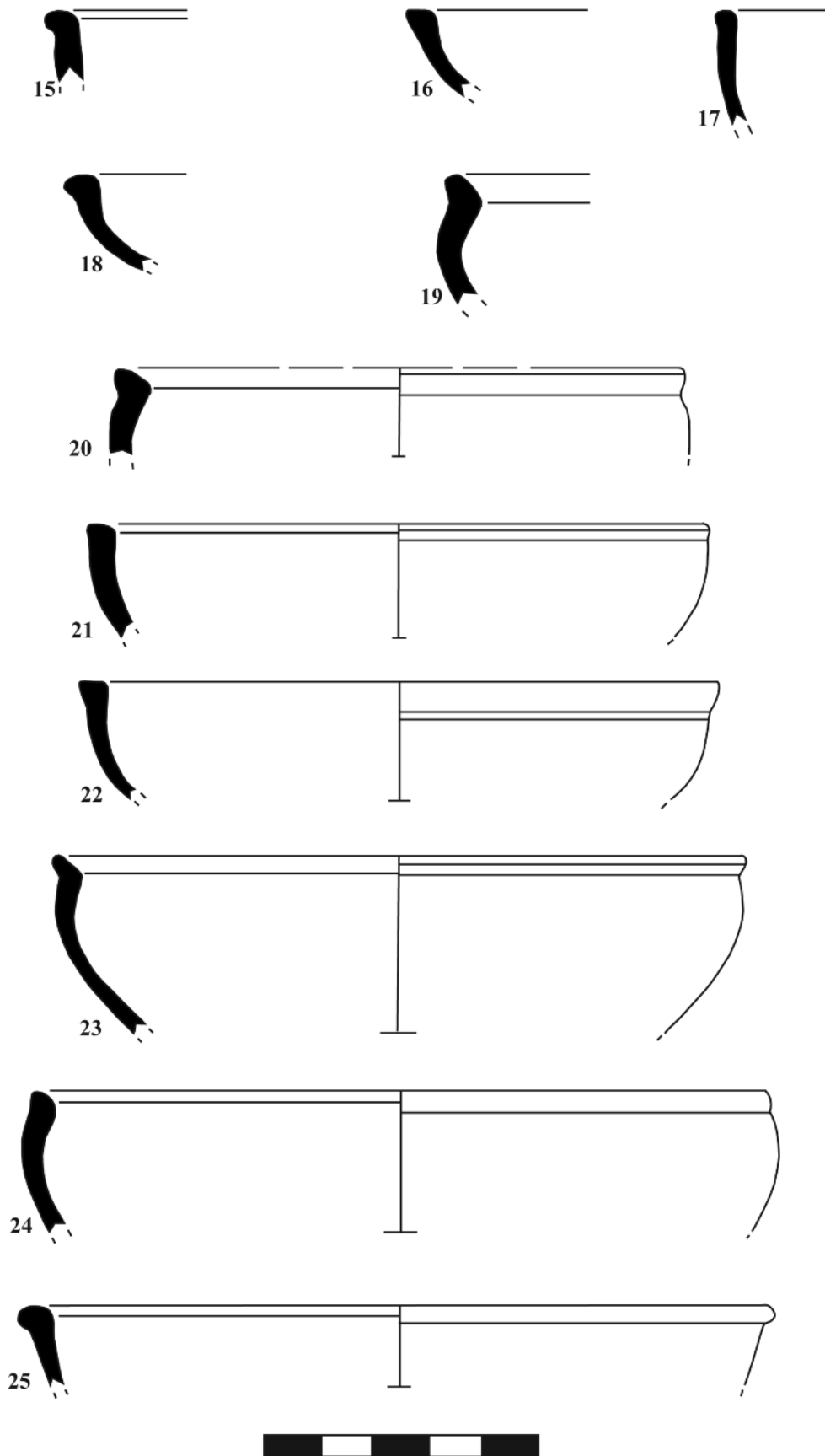

Pl. 4 : N<sup>os</sup> 15-25 – Local sigillata, fragments of bowl form 2.

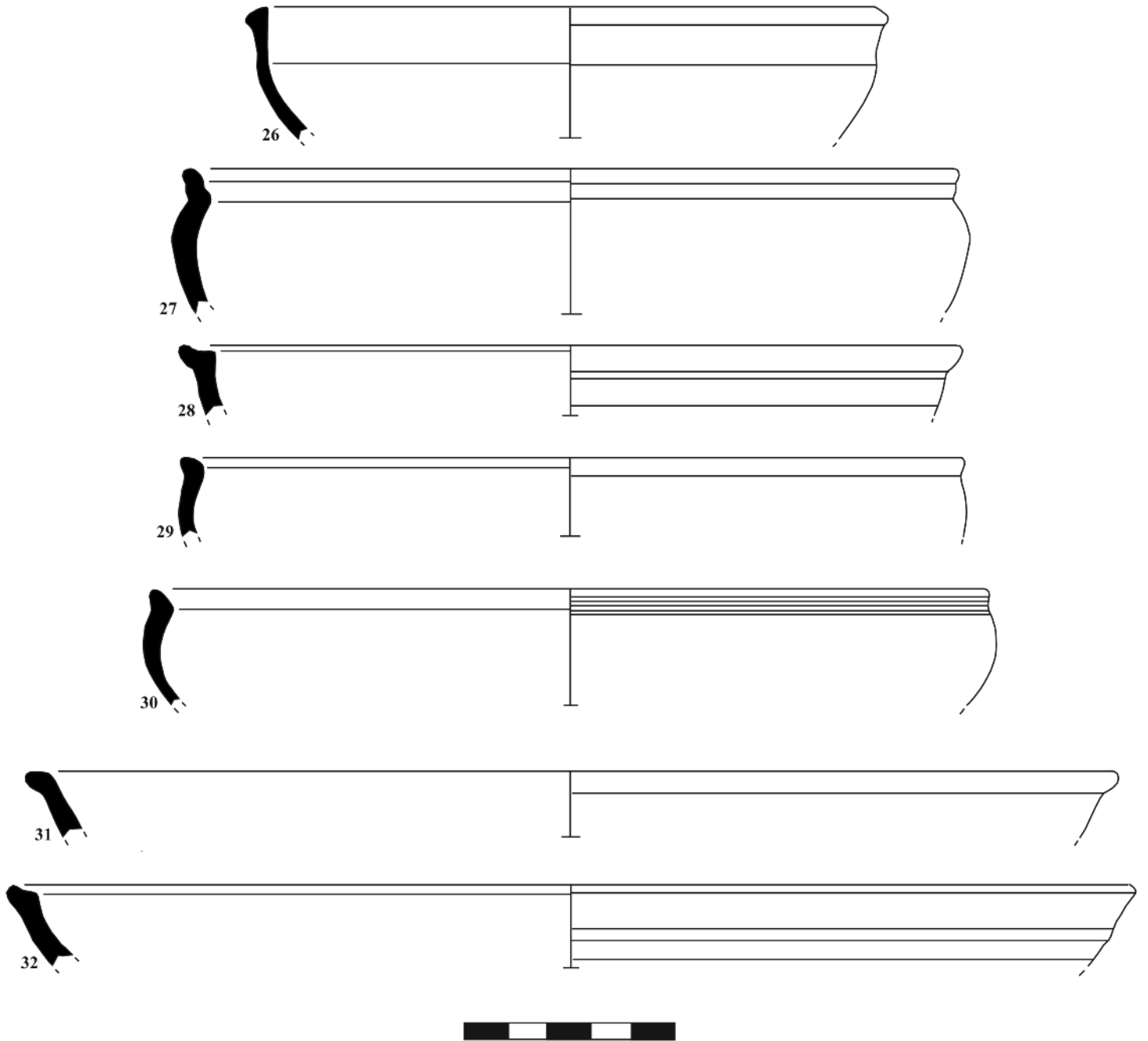

Pl. 5 : N<sup>os</sup> 26-32 – Local sigillata, fragments of bowl form 2.

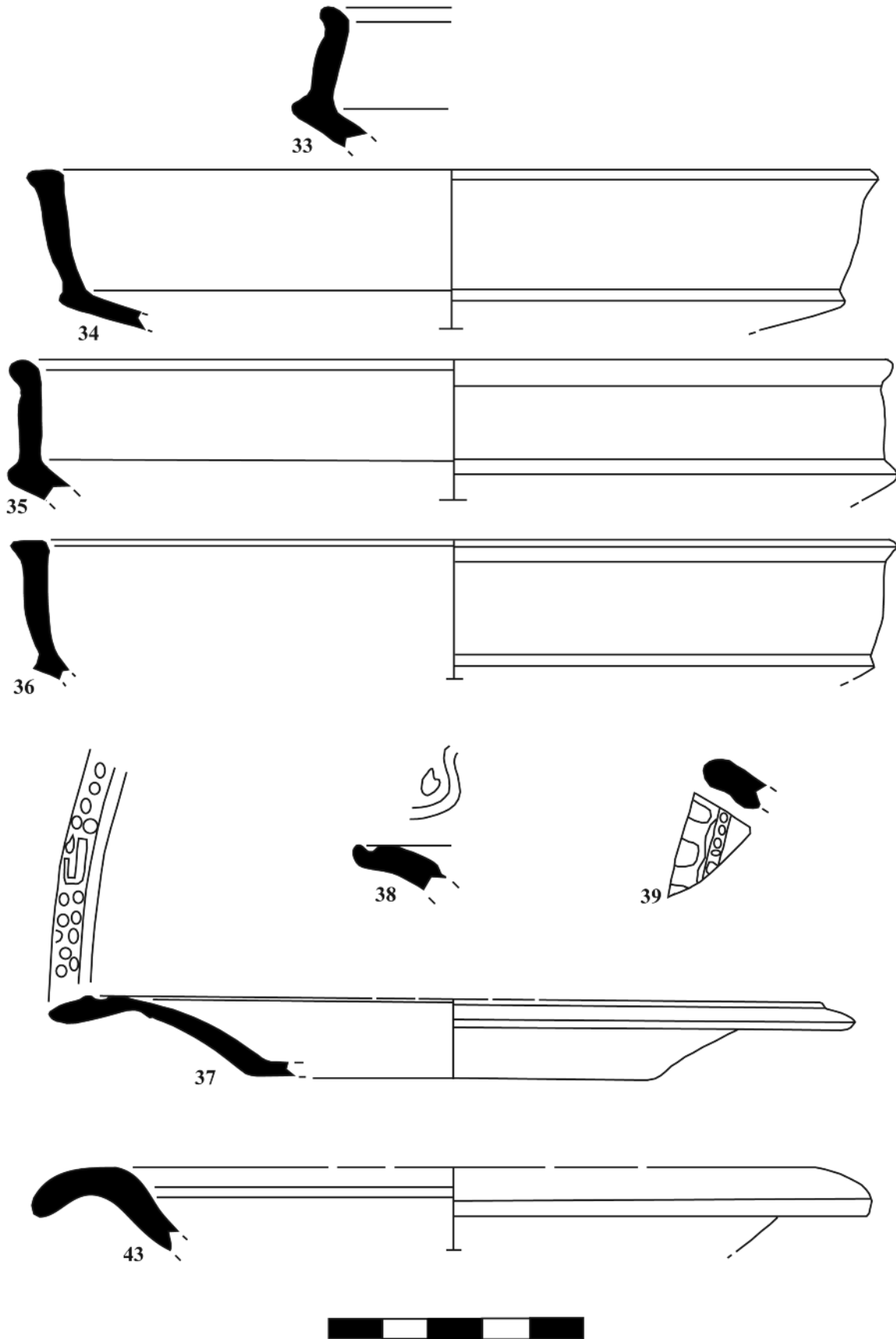

Pl. 6 : N<sup>os</sup> 33-36 – Local sigillata, fragments of dish form 1; n<sup>os</sup> 37-39 – Dish form 2; n<sup>o</sup> 43 – Dish form 4.

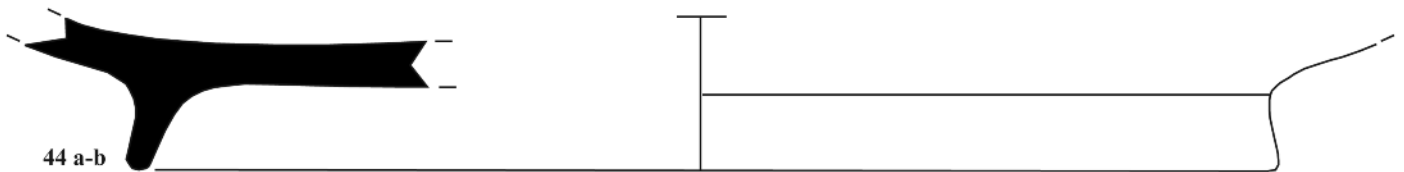
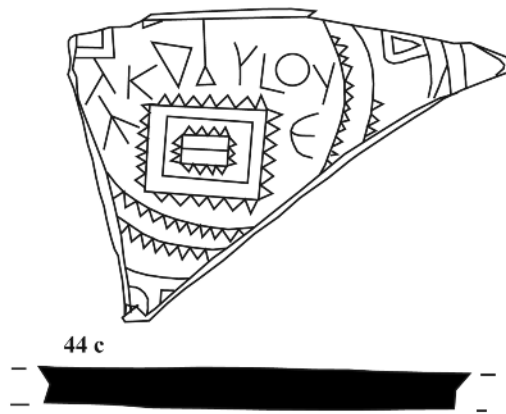
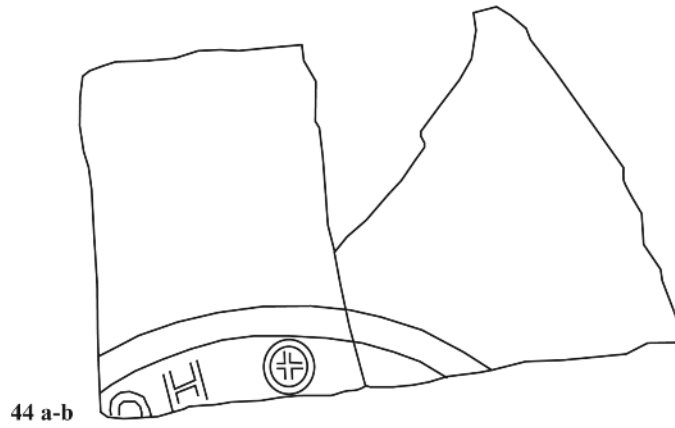

Pl. 7 : N° 44a-c – Local sigillata, three fragments of a plate.

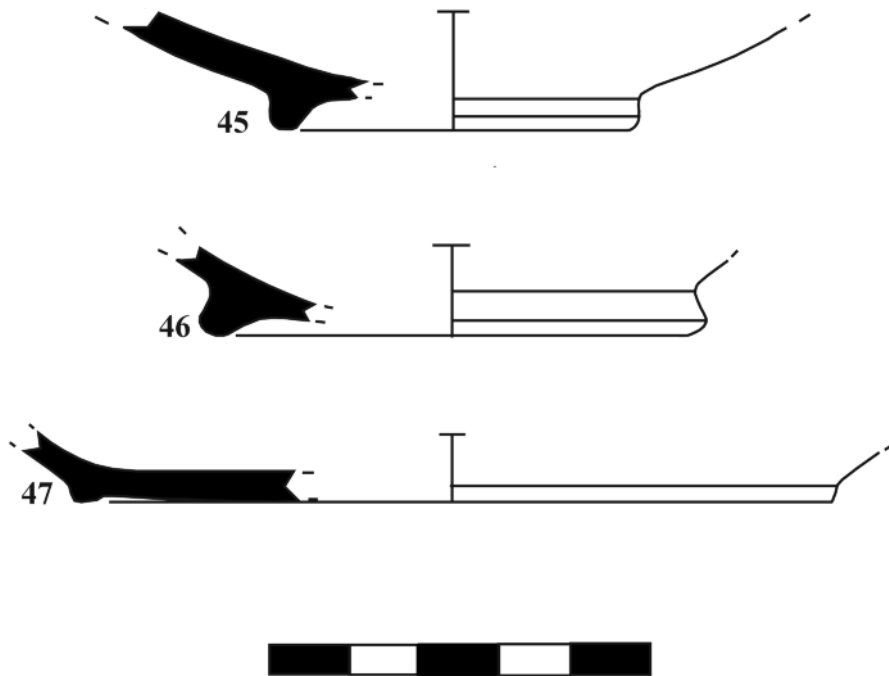

Pl. 8 : N<sup>os</sup> 45-47 – Local sigillata, base fragments of open forms.

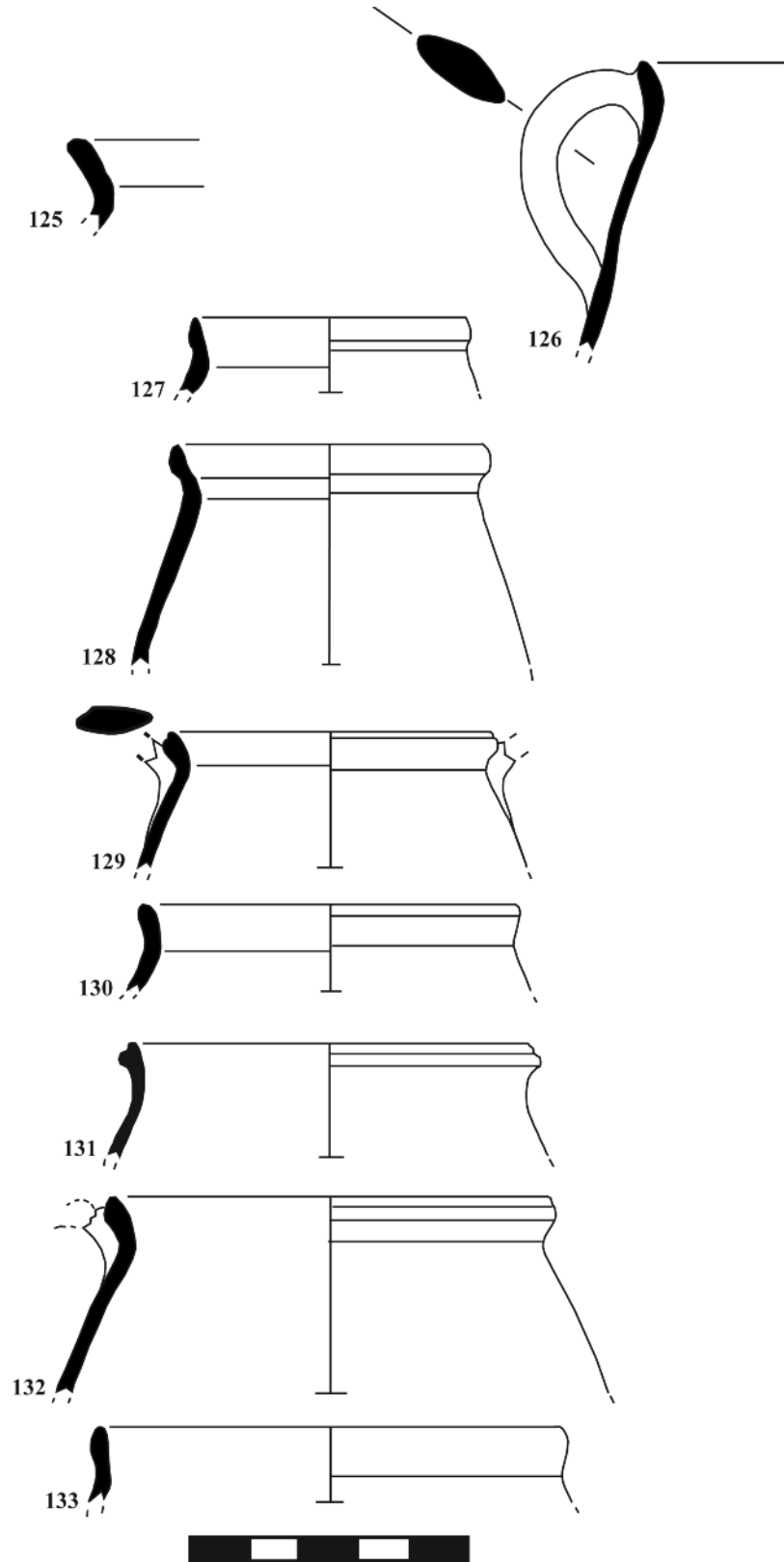

Pl. 9 : Nos 125-133 – Local sigillata, juglet fragments.

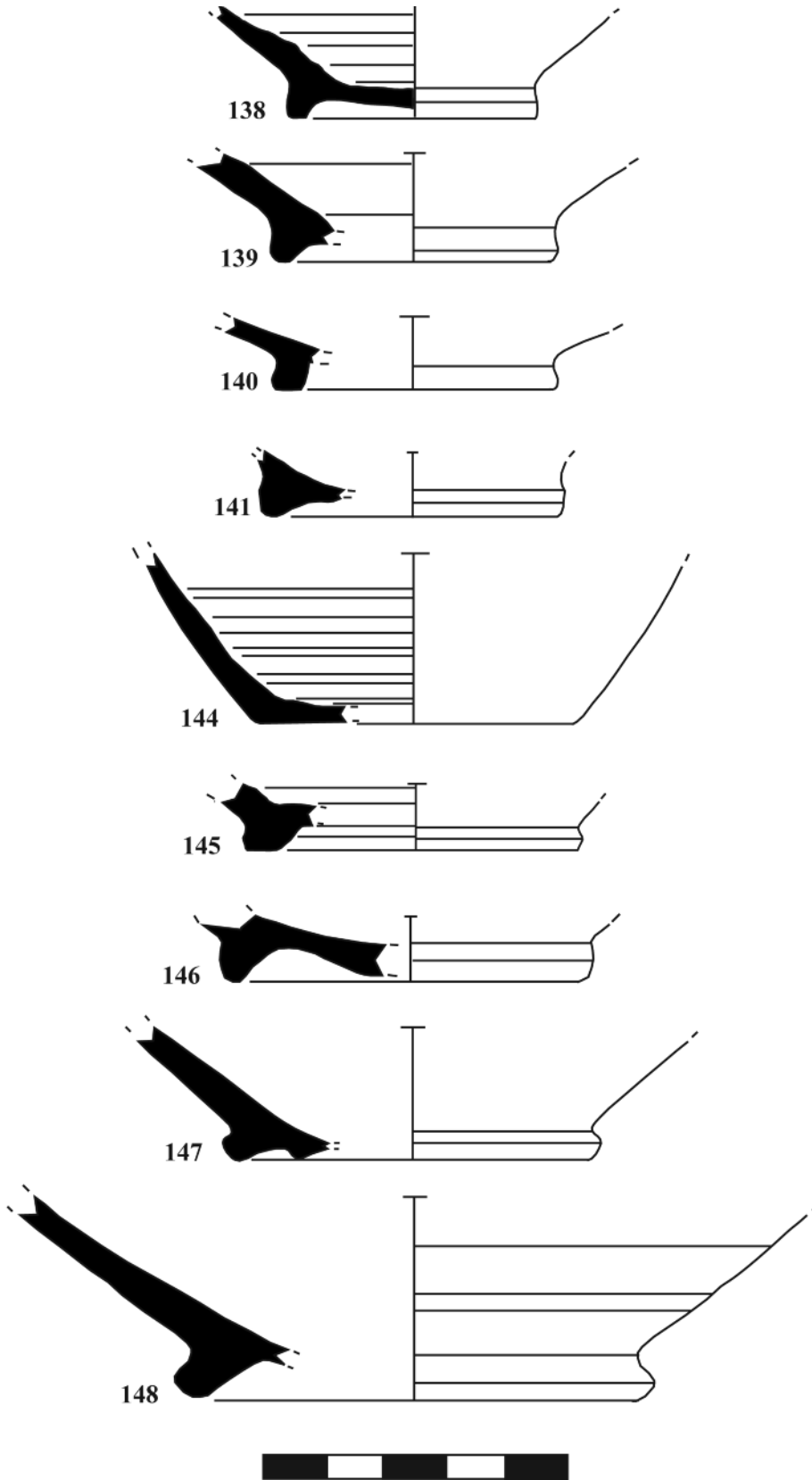

Pl. 10 : N<sup>os</sup> 138-148 – Local sigillata, base fragments of closed forms.

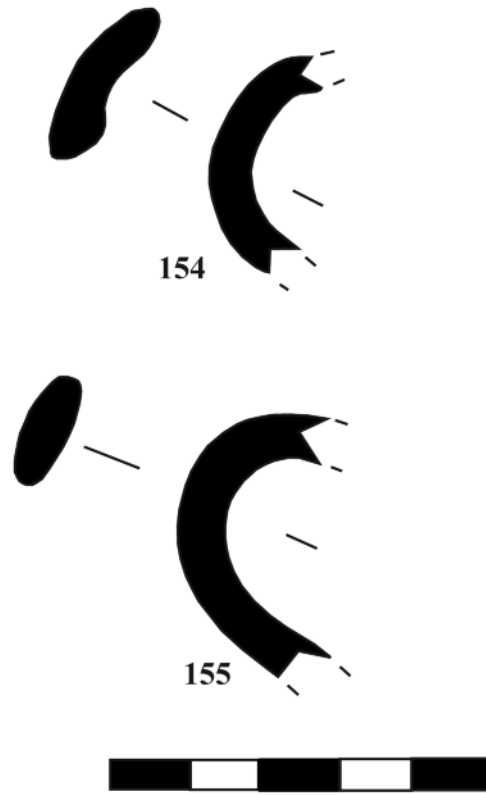

Pl. 11 : N<sup>os</sup> 154-155 – Local sigillata, handle fragments of closed forms.

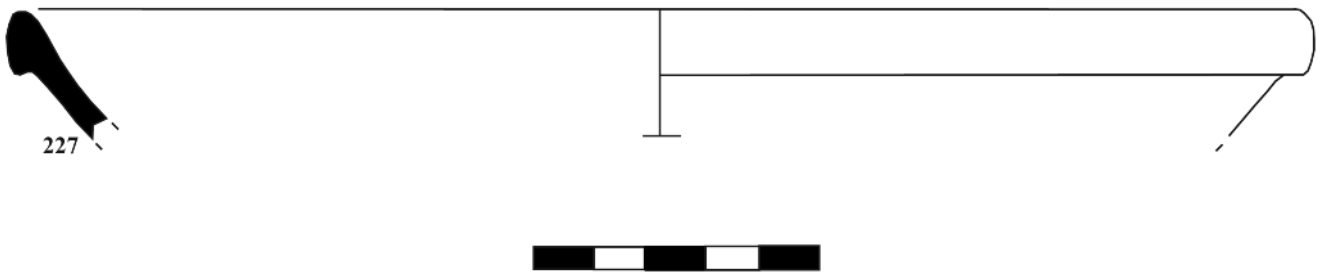

Pl. 12 : N<sup>o</sup> 227 – Fragment of an African red-slipped bowl.

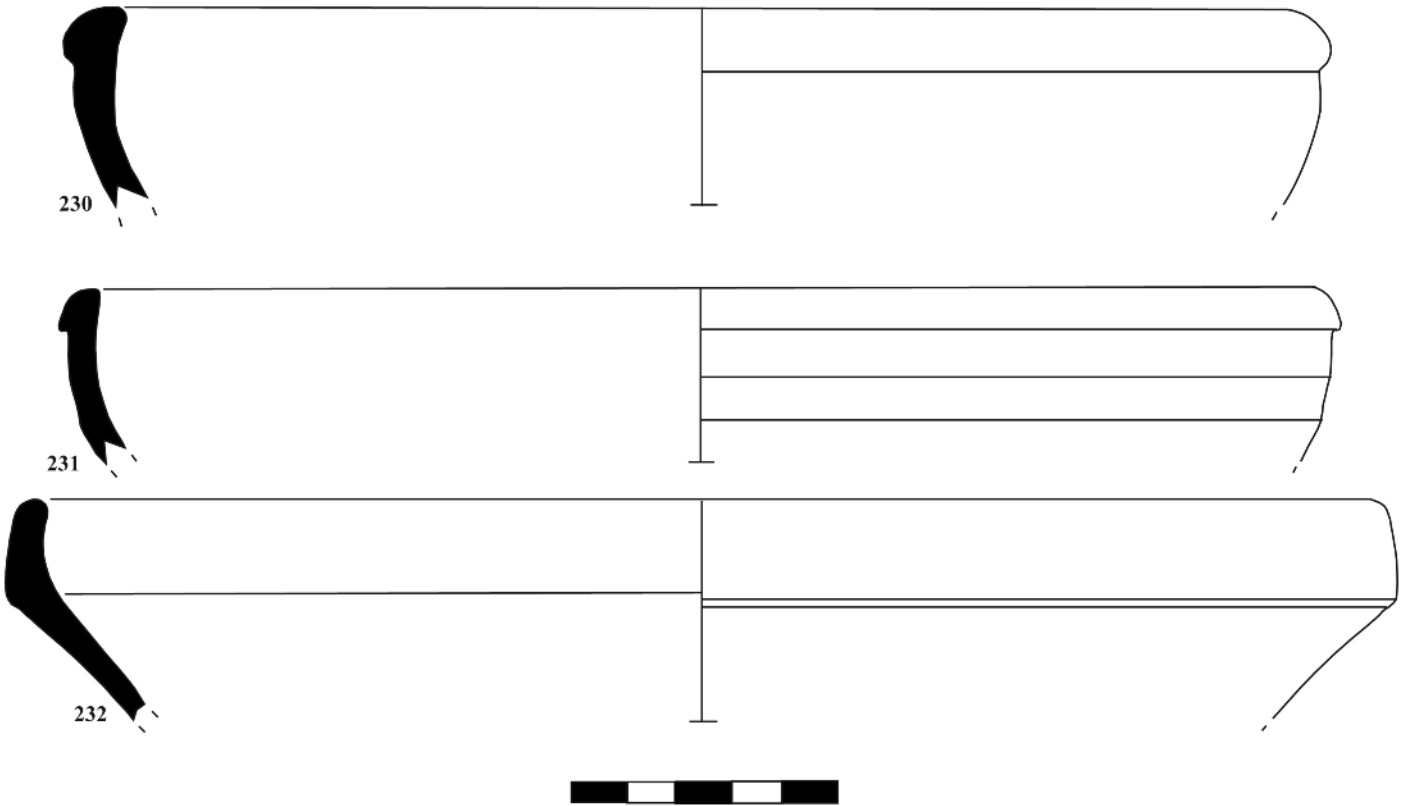

Pl. 13 : N<sup>os</sup> 228-232 – Local red-slipped ware, fragments of bowl form 1.

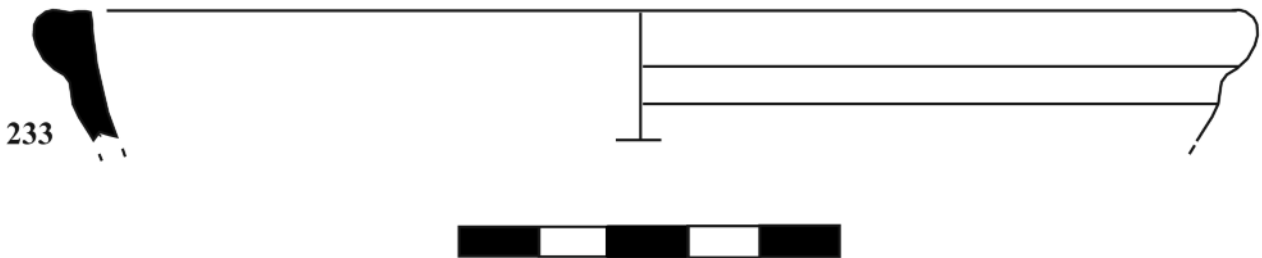

Pl. 14 : N<sup>o</sup> 233 – Local red-slipped ware, fragment of bowl form 2.

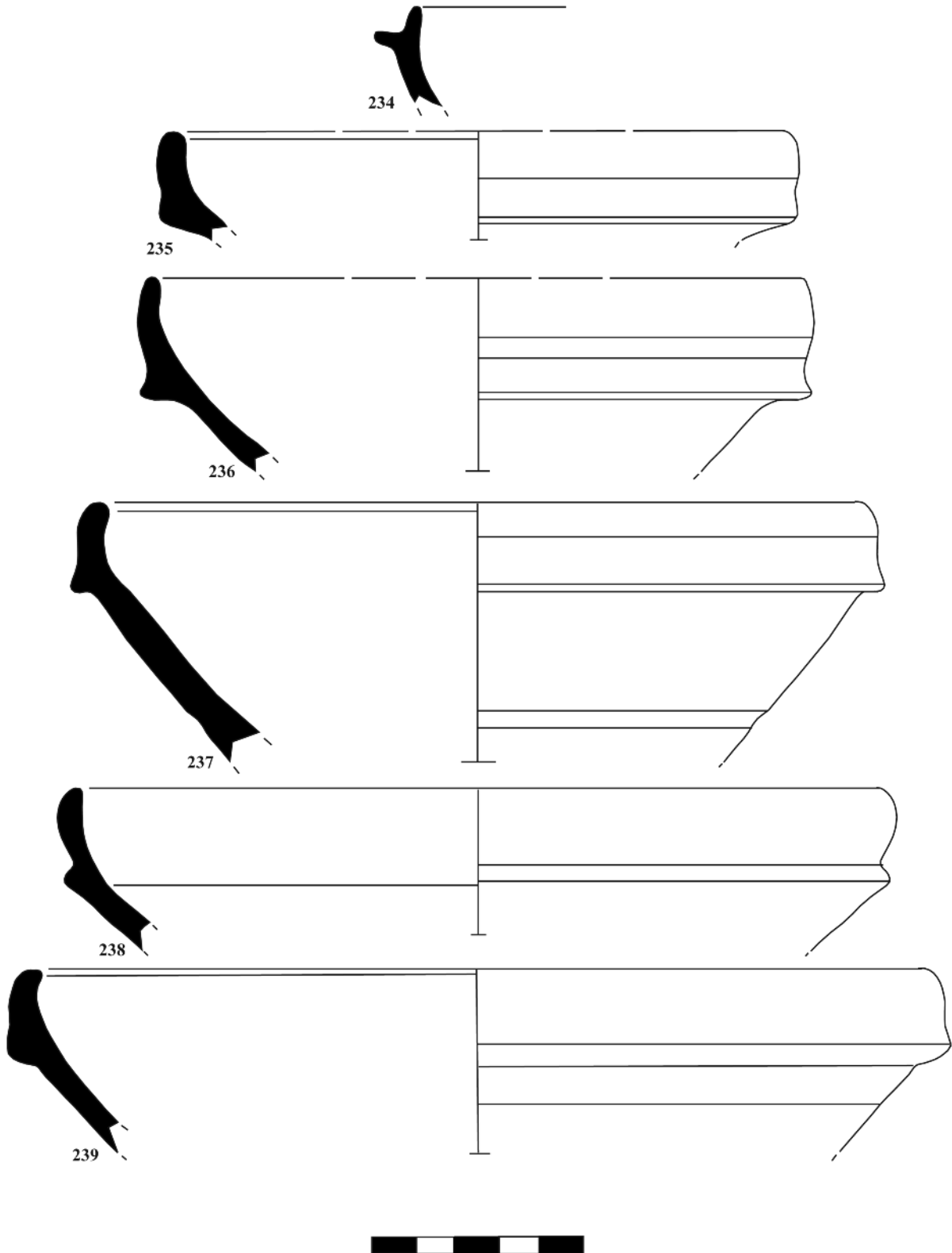

Pl. 15 : N<sup>os</sup> 234-239 – Local red-slipped ware, fragments of bowl form 3.

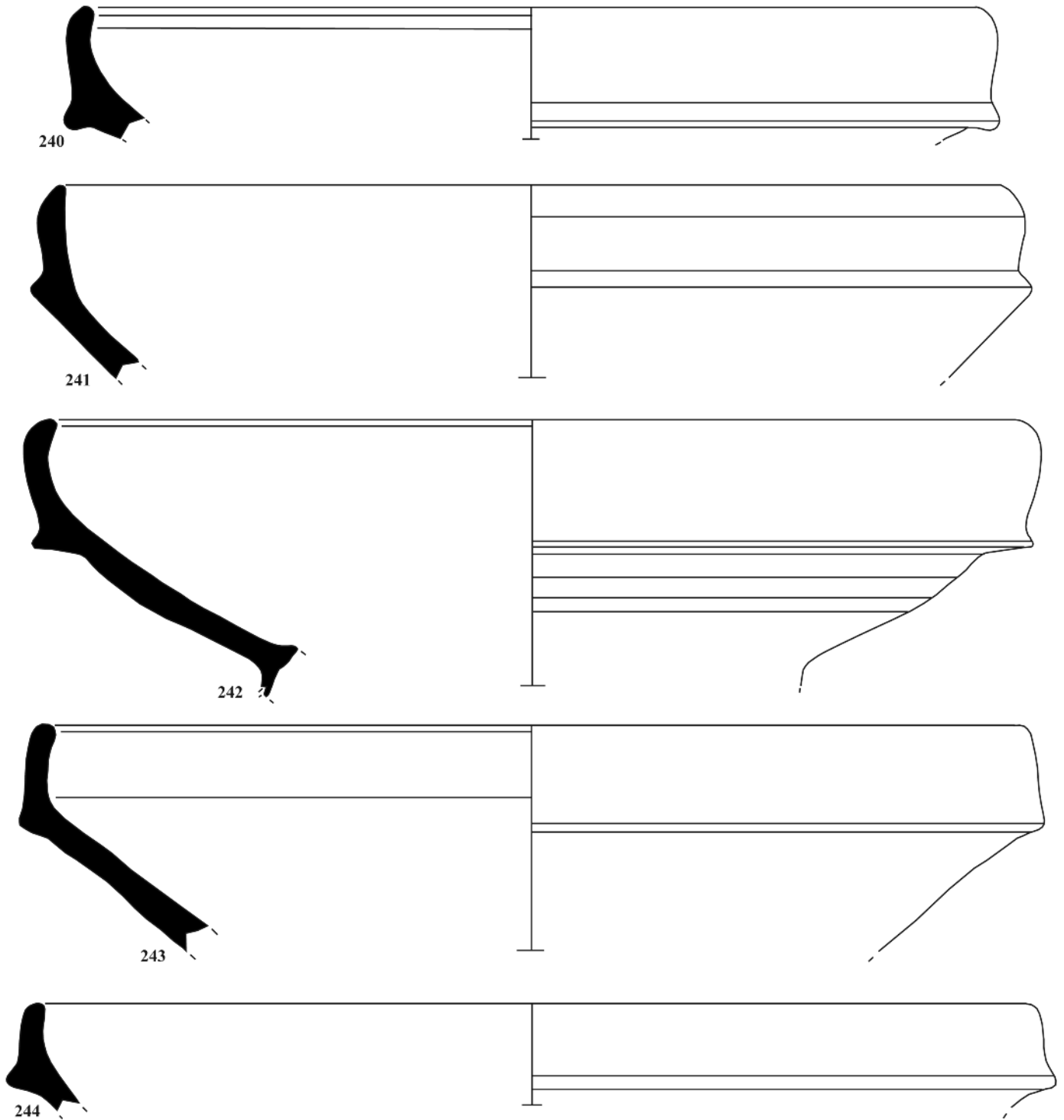

Pl. 16 : N<sup>os</sup> 240-244 – Local red-slipped ware, fragments of bowl form 3.

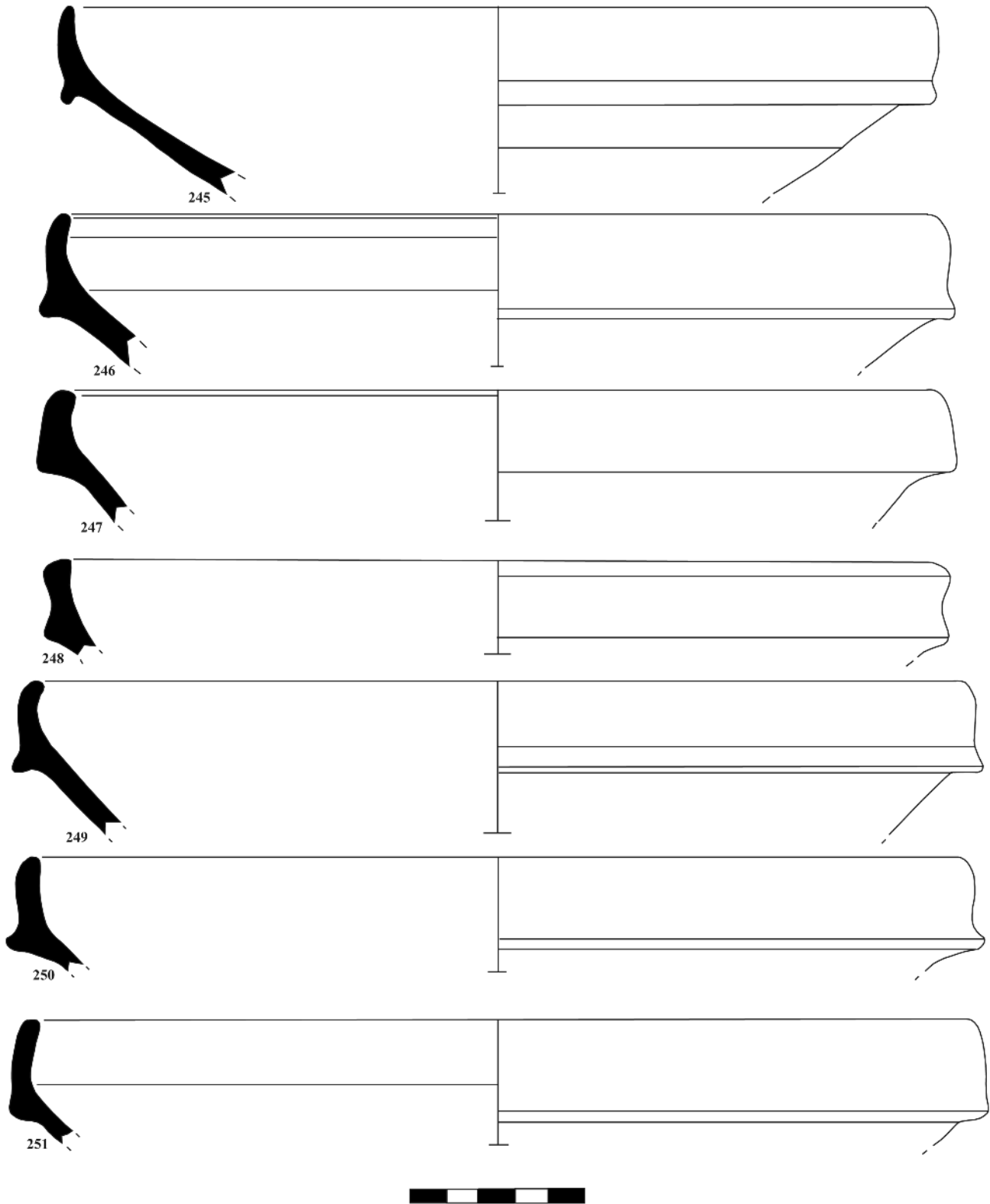

Pl. 17 : N<sup>os</sup> 245-251 – Local red-slipped ware, fragments of bowl form 3.

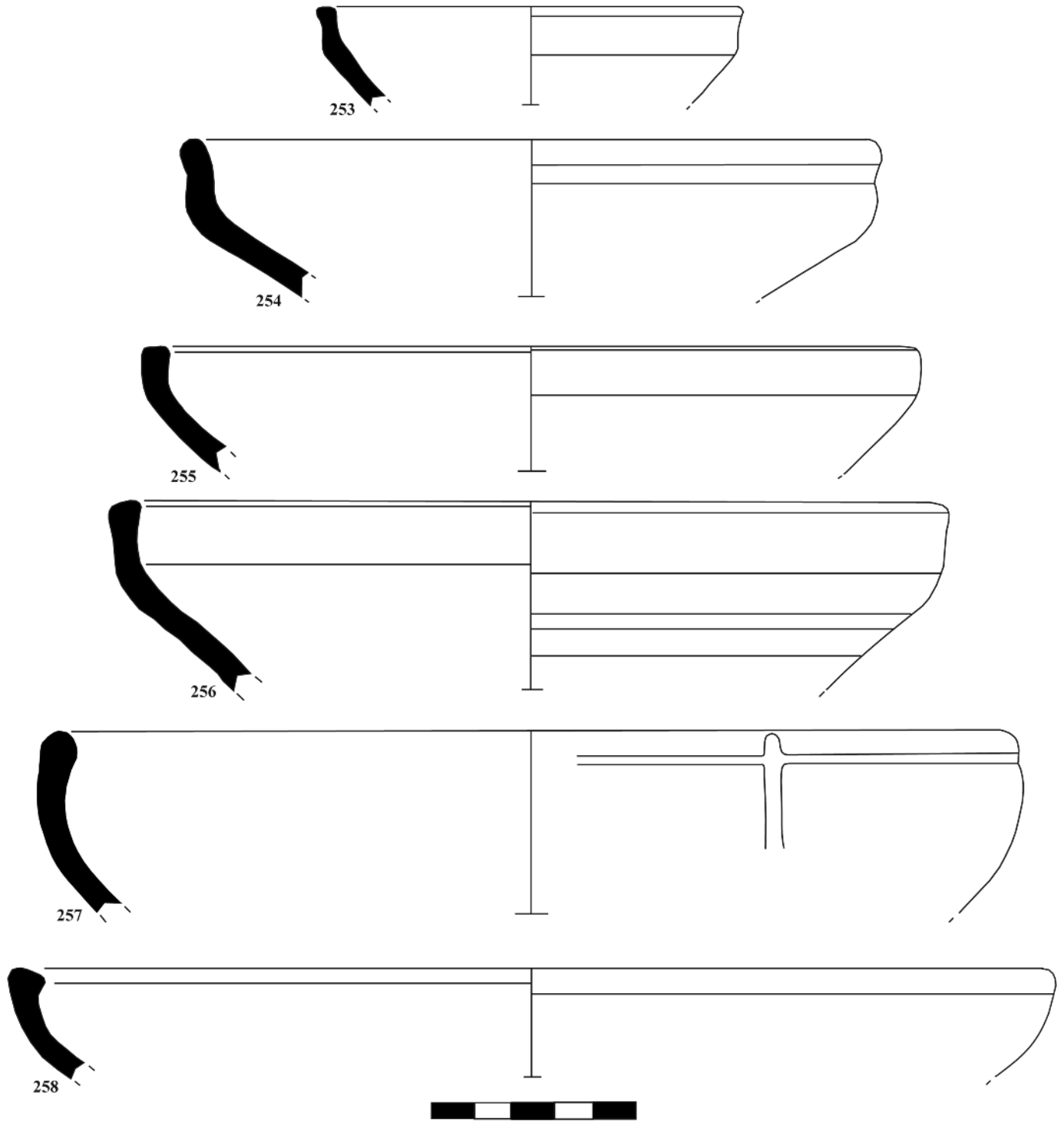

Pl. 18 : N<sup>os</sup> 253-258 – Local red-slipped ware, fragments of bowl form 4.

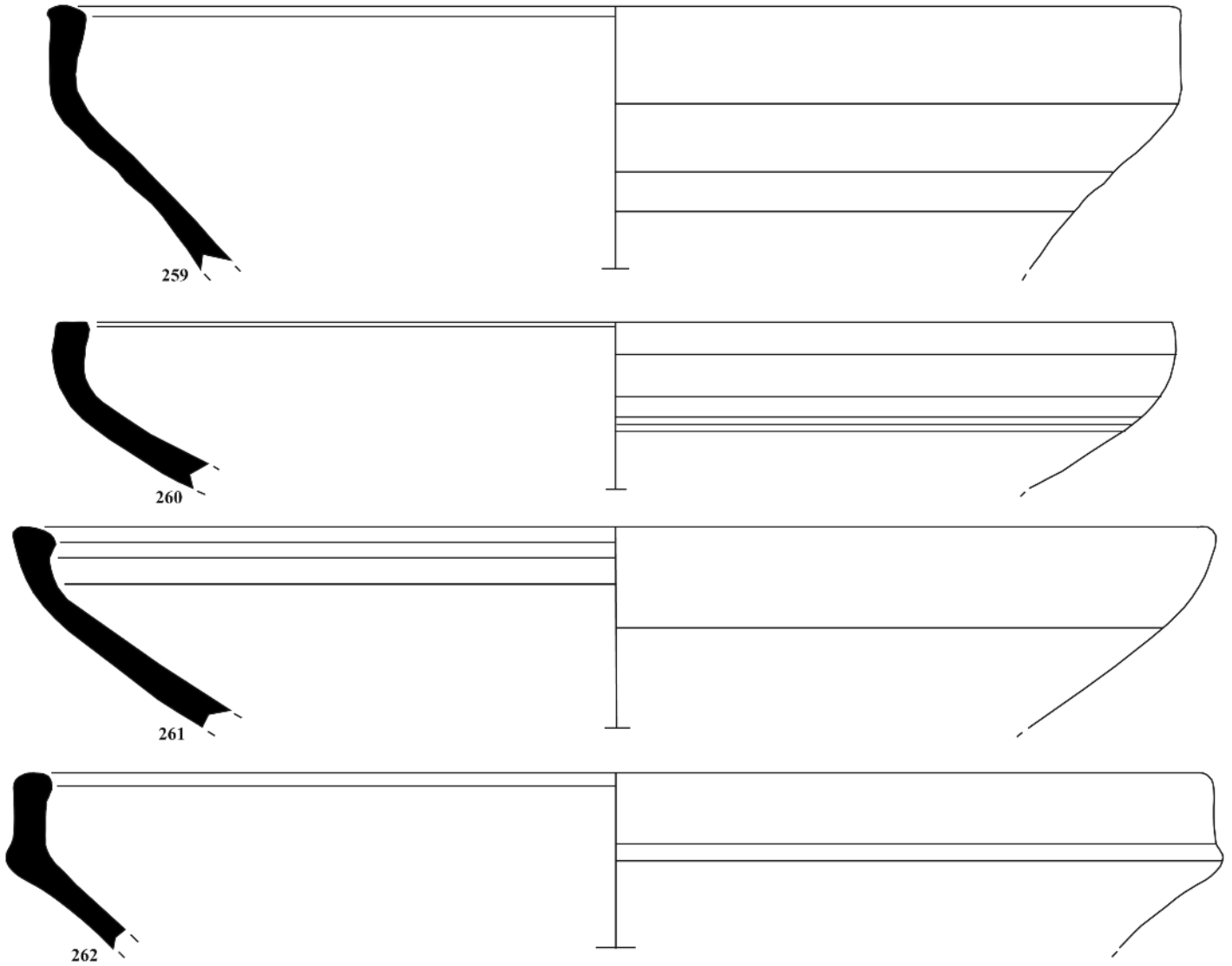

Pl. 19 : N<sup>os</sup> 259-262 – Local red-slipped ware, fragments of bowl form 4.

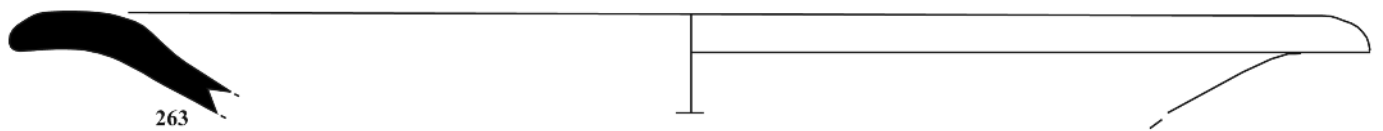

Pl. 20 : N<sup>o</sup> 263 – Local red-slipped ware, a dish fragment.

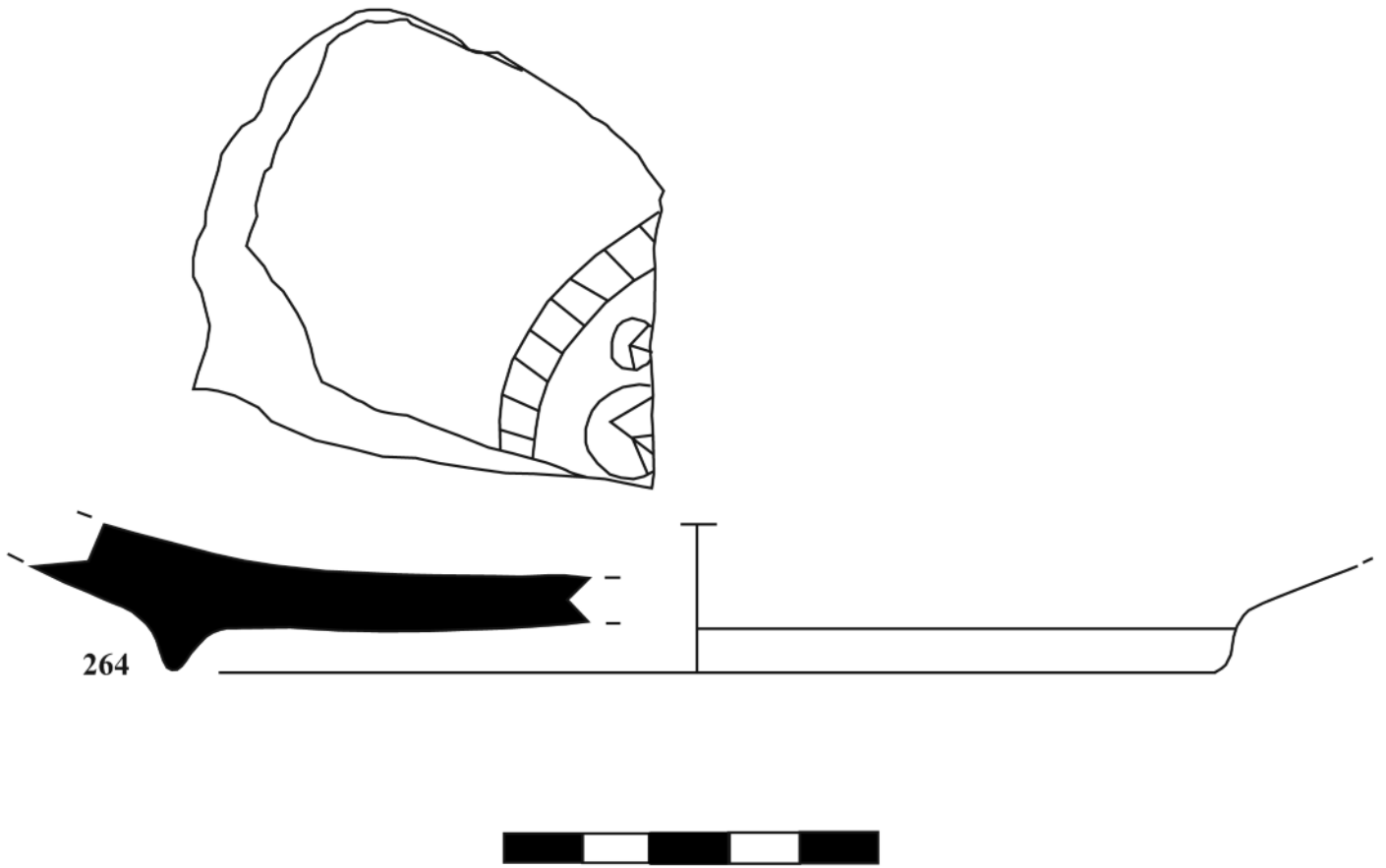

Pl. 21 : N° 264 – Local red-slipped ware, base fragment of an open form.

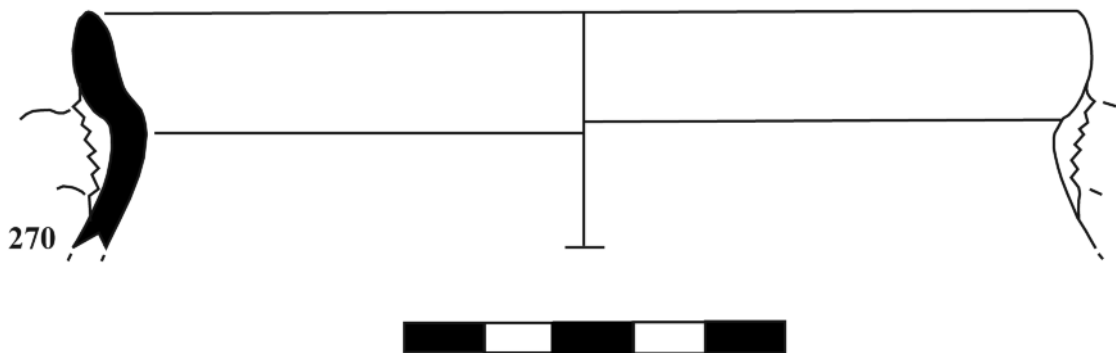

Pl. 22 : N° 270 – Local red-slipped ware, fragment of a jug/small pot?



Pl. 24 : N° 5 – Local sigillata, a cup fragment.

Pl. 23 : N°s 1-4 – Imported terra sigillata sherds; n° 1 – ESA bowl fragment; n° 2 – ESA dish fragment; n° 3 – ESA dish fragment; n° 4 – ESA bowl fragment.

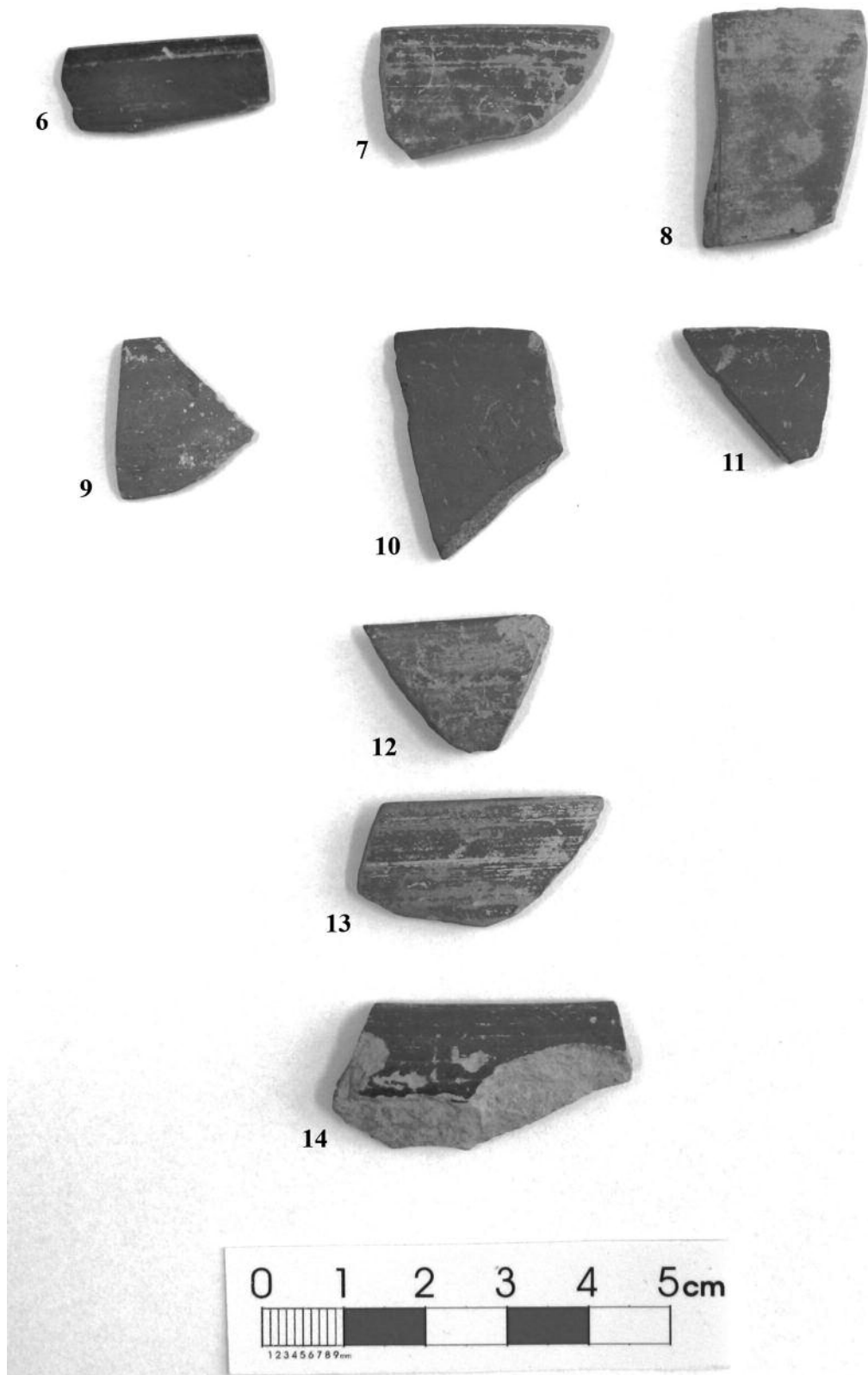

Pl. 25 : N<sup>os</sup> 6-14 – Local sigillata, fragments of bowl form 1.

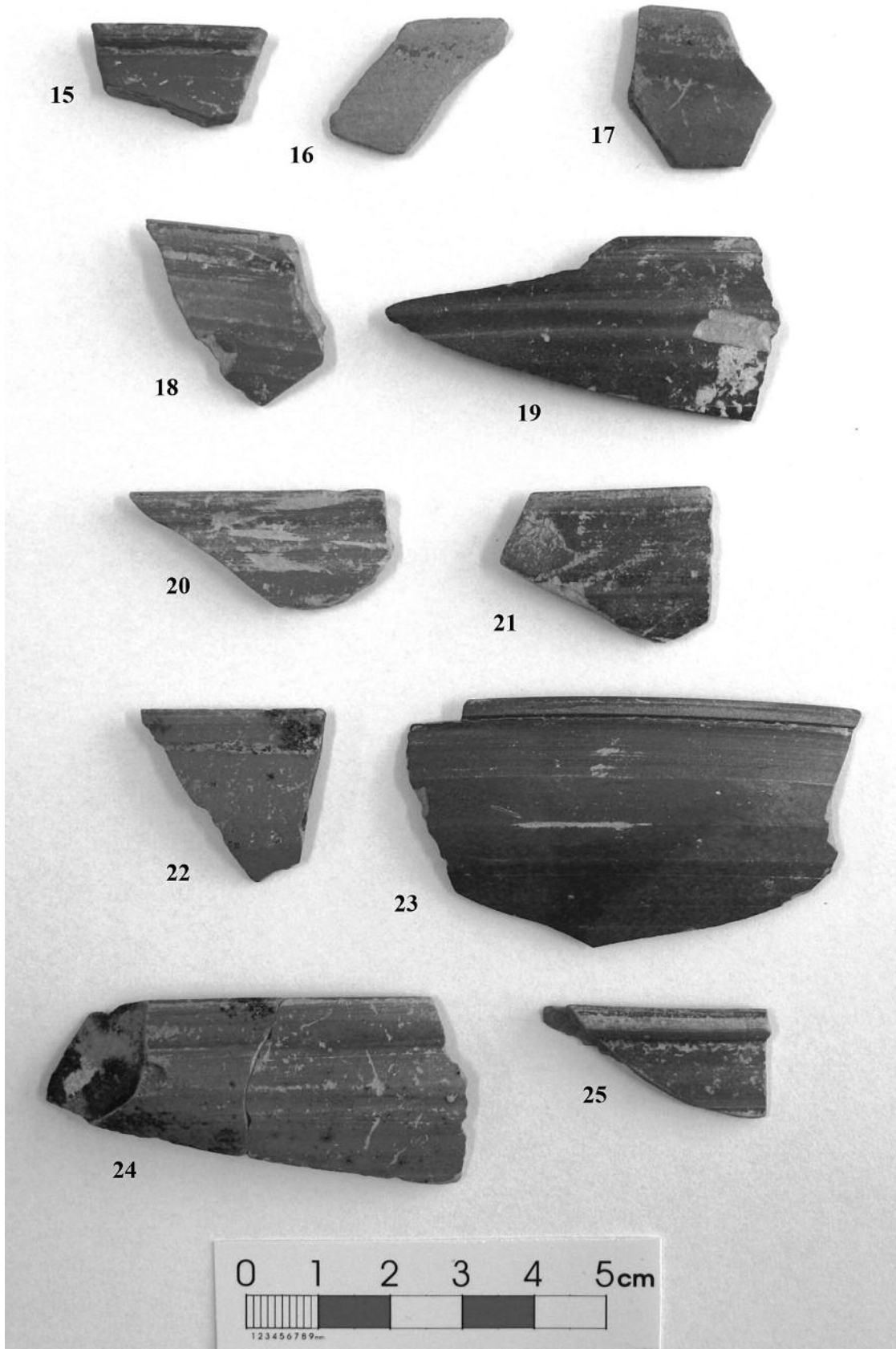

Pl. 26 : N<sup>os</sup> 15-25 – Local sigillata, fragments of bowl form 2.

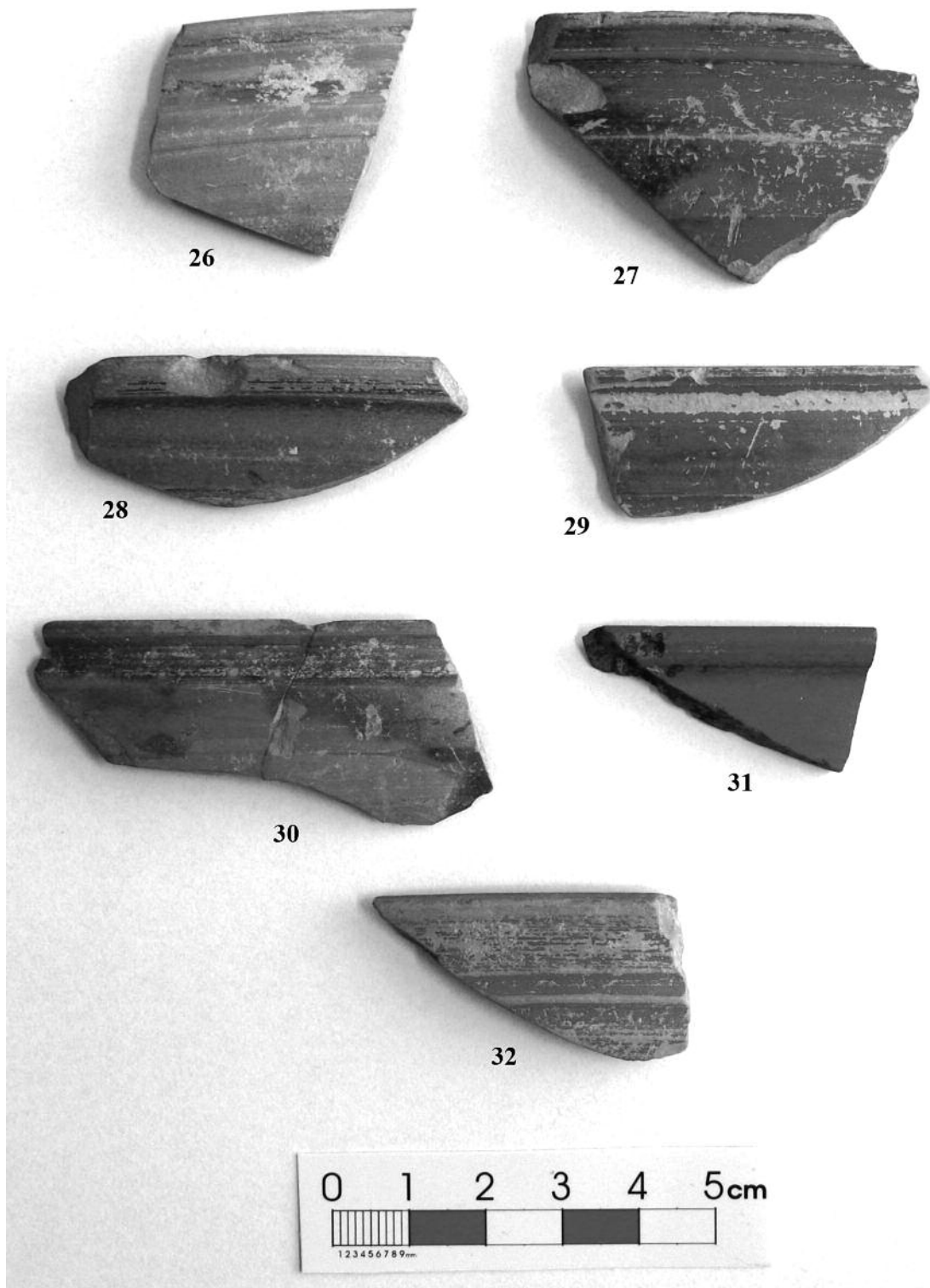

Pl. 27 : N<sup>os</sup> 26-32 – Local sigillata, fragments of bowl form 2.

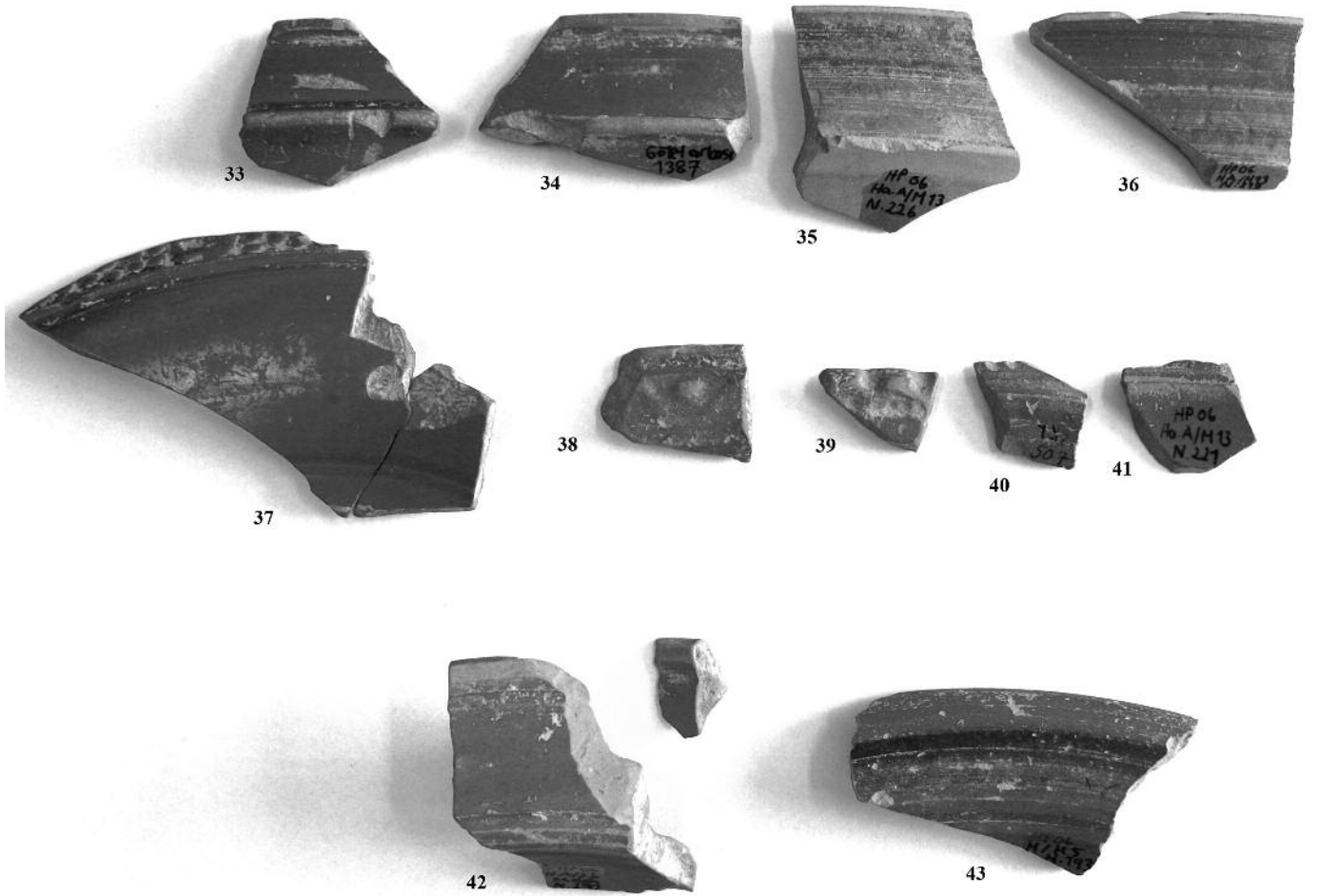

Pl. 28 : N<sup>os</sup> 33-36 – Local sigillata, fragments of dish form 1;  
 n<sup>os</sup> 37-41 – Dish form 2; n<sup>o</sup> 42 – Dish form 3; n<sup>o</sup> 43 – Dish form 4.

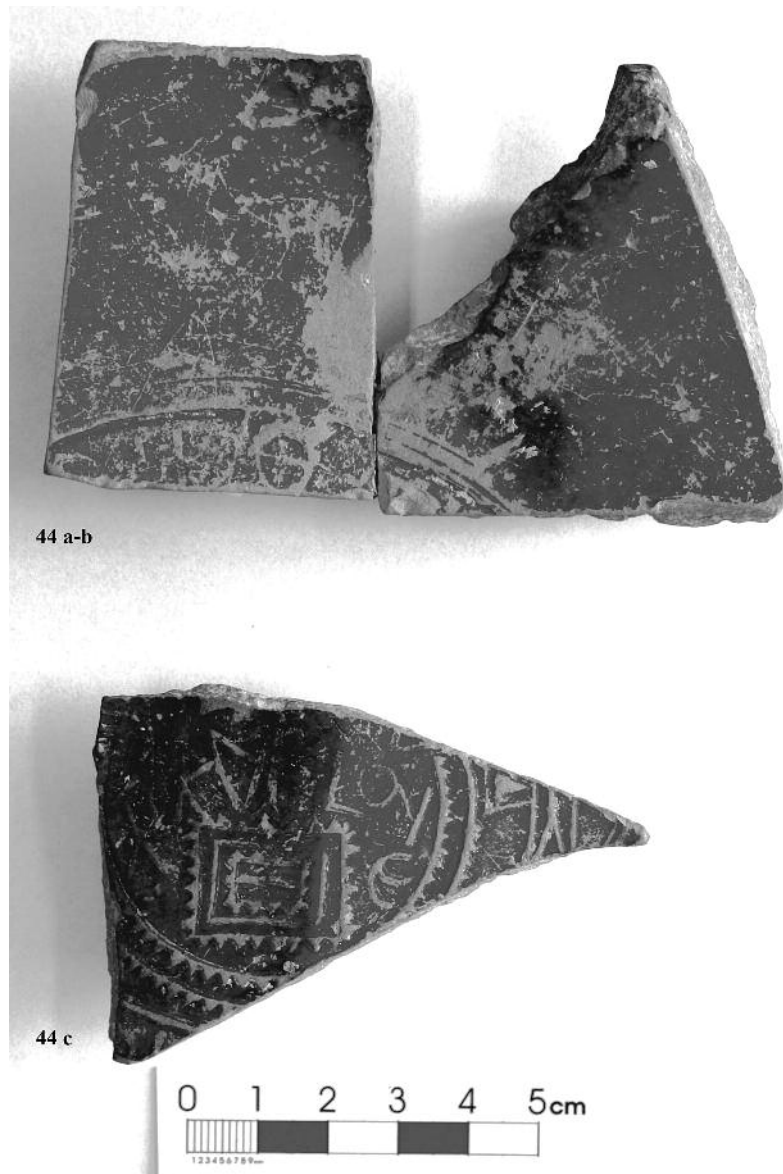

Pl. 29 : N° 44a-c – Local sigillata, three fragments of a plate.

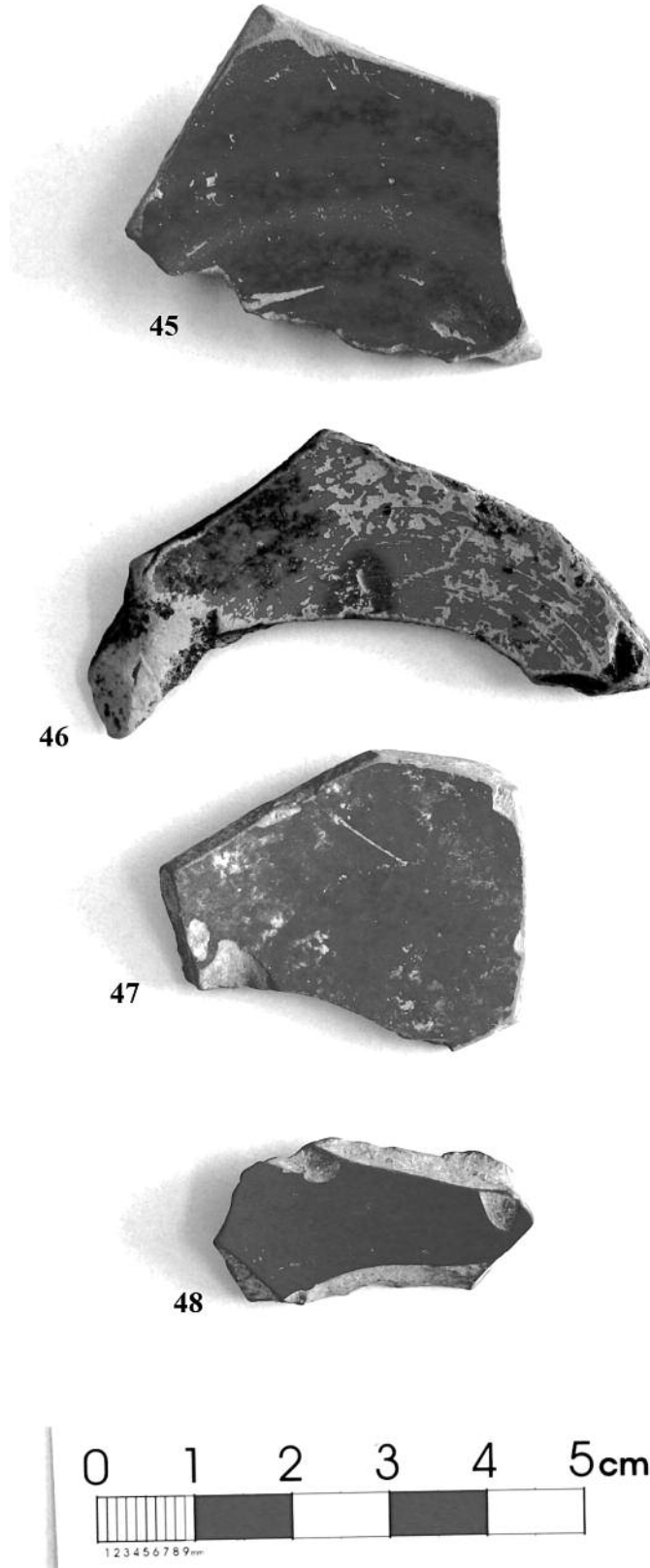

Pl. 30 : N<sup>os</sup> 45-48 – Local sigillata, base fragments of open forms.



Pl. 31 : N<sup>os</sup> 49-87 – Local sigillata, body fragments of open forms.

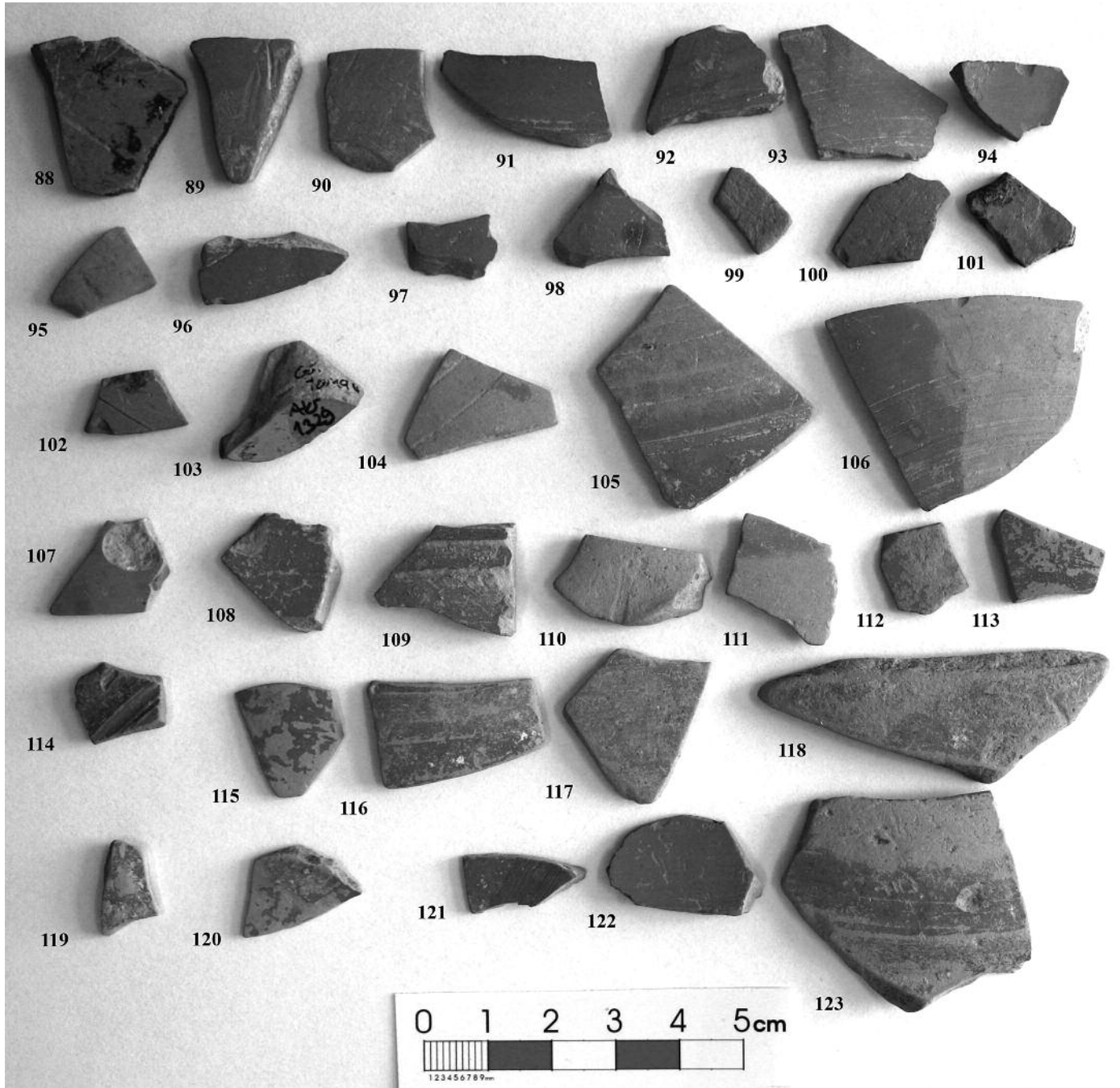

Pl. 32 : N<sup>os</sup> 88-123 – Local sigillata, body fragments of open forms.

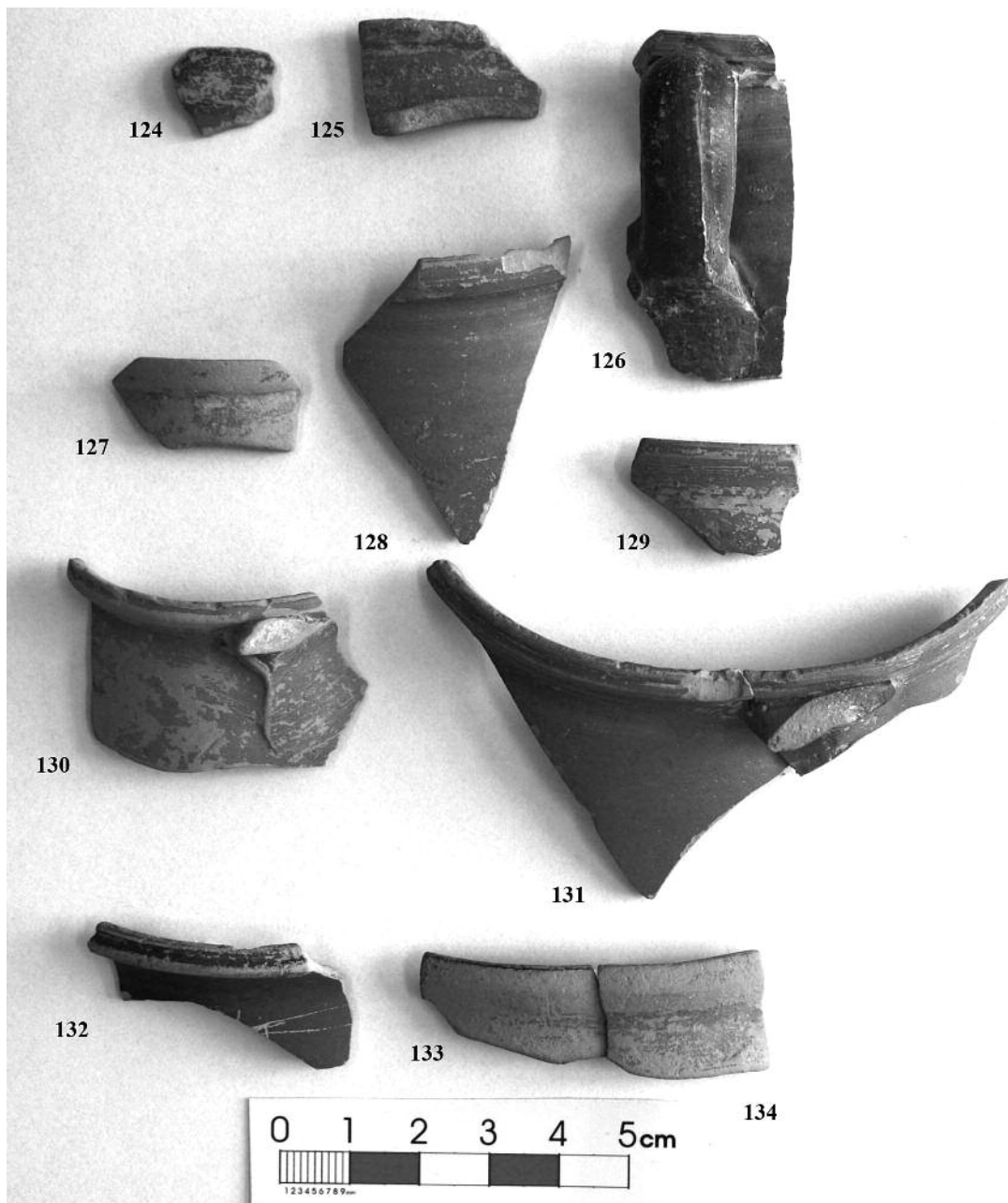

Pl. 33 : N<sup>os</sup> 124-134 – Local sigillata, juglet fragments.

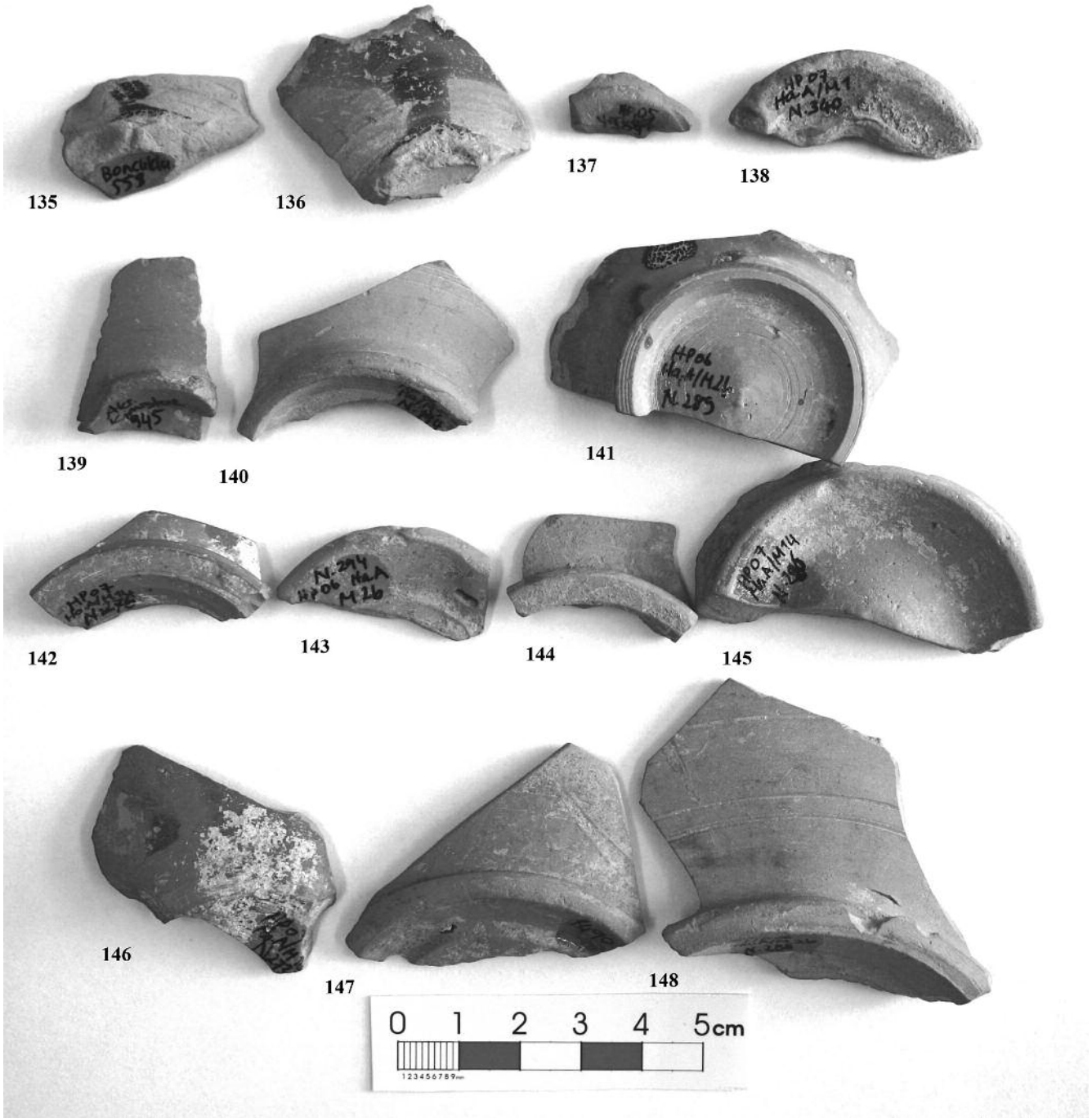

Pl. 34 : N<sup>os</sup> 135-148 – Local sigillata, base fragments of closed forms.

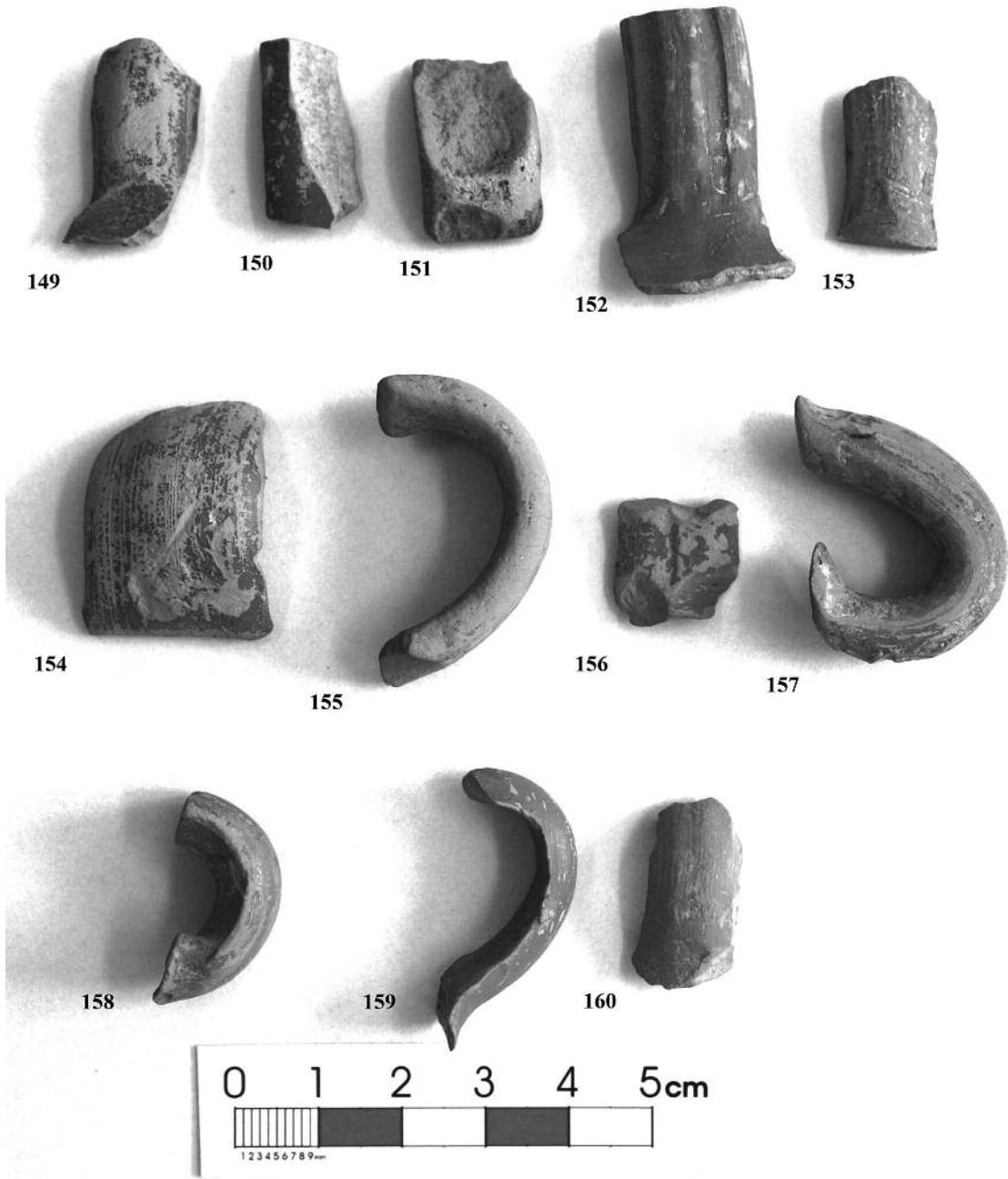

Pl. 35 : N<sup>os</sup> 149-160 – Local sigillata, handle fragments of closed forms.

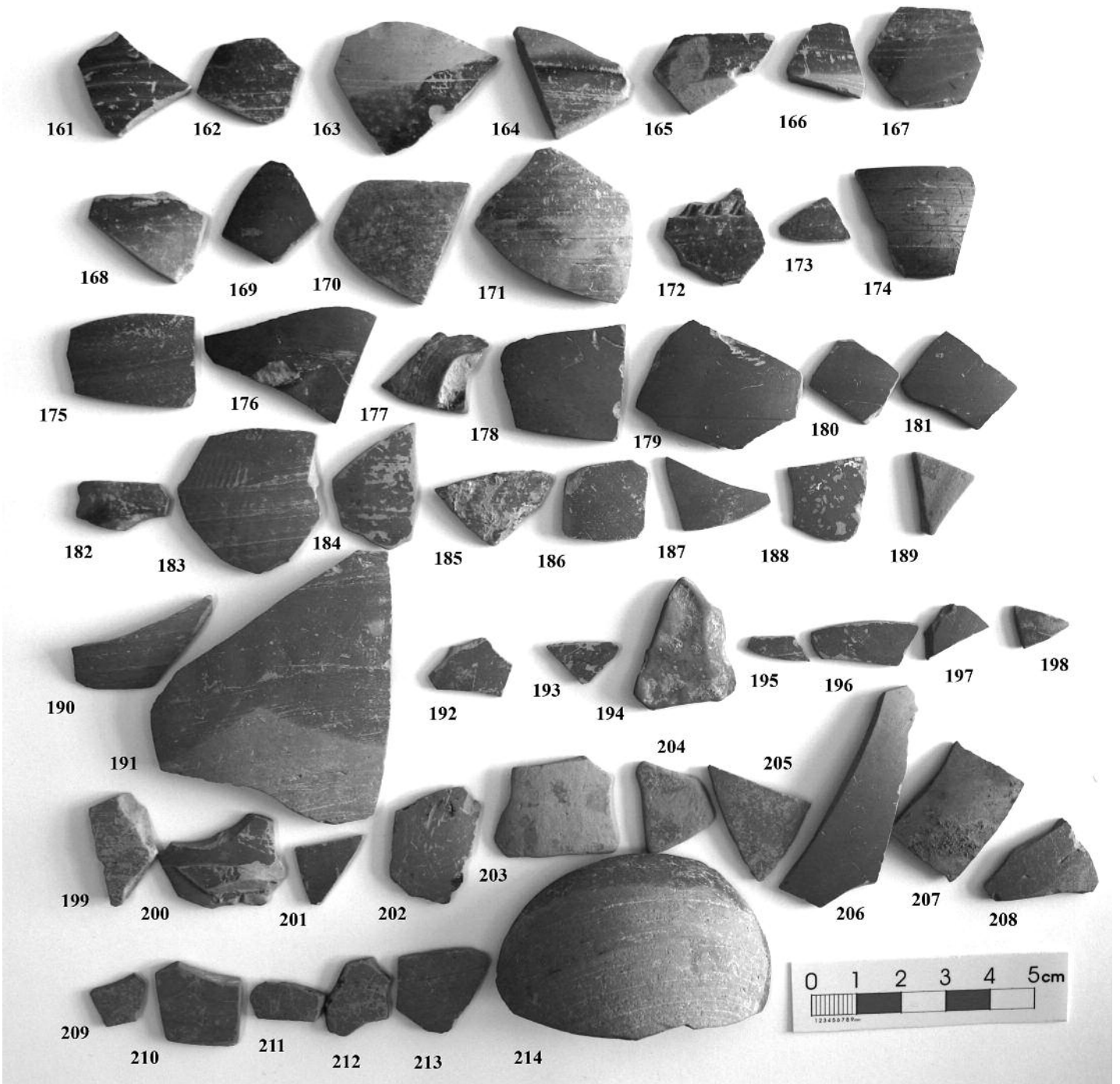

Pl. 36 : N<sup>os</sup> 161-214 – Local sigillata, body fragments of closed forms.



Pl. 37 : N<sup>os</sup> 215-224 – Local sigillata, rim fragments without any form definition.



Pl. 38 : N<sup>os</sup> 225-226 – Lamp fragments in sigillata tradition.

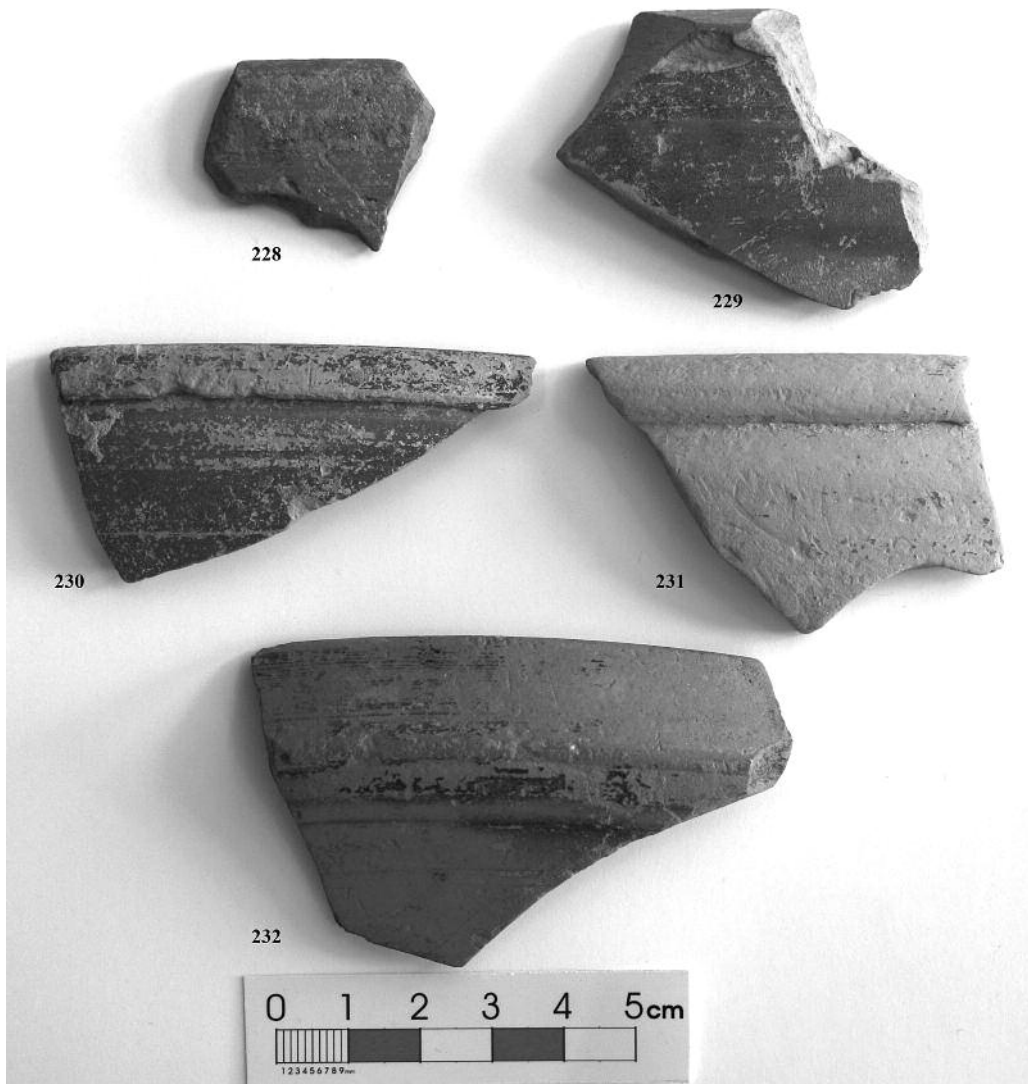

Pl. 39 : Nos 228-232 – Local red-slipped ware, fragments of bowl form 1.

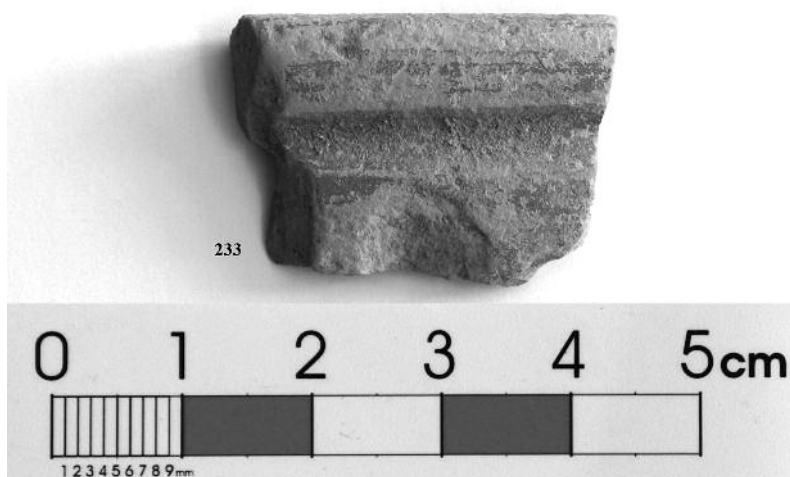

Pl. 40 : N° 233 – Local red-slipped ware, a fragment of bowl form 2.



Pl. 41 : N<sup>os</sup> 234-242 – Local red-slipped ware, fragments of bowl form 3.



Pl. 42 : N<sup>os</sup> 243-252 – Local red-slipped ware, fragments of bowl form 3.



**Pl. 43: N<sup>os</sup> 253-262 – Local red-slipped ware, fragments of bowl form 4.**



**Pl. 44 : N<sup>o</sup> 263 – Local red-slipped ware, a dish fragment.**

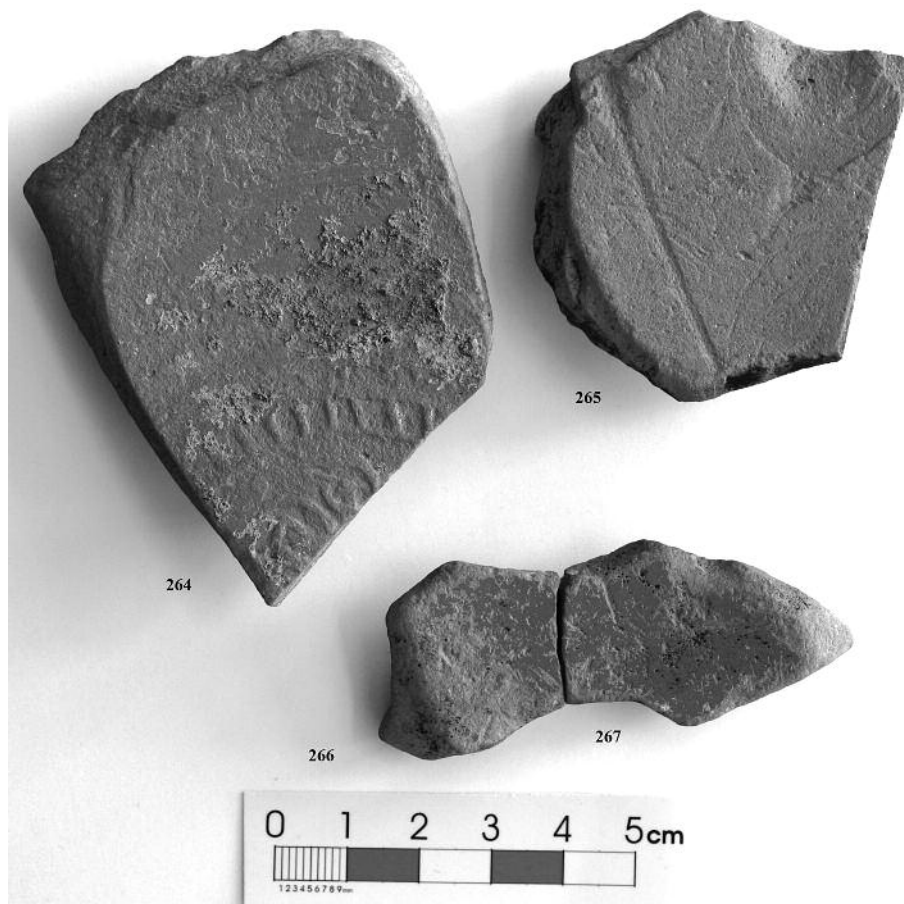

Pl. 45 : N<sup>os</sup> 264-267 – Local red-slipped ware, base fragments of open forms.

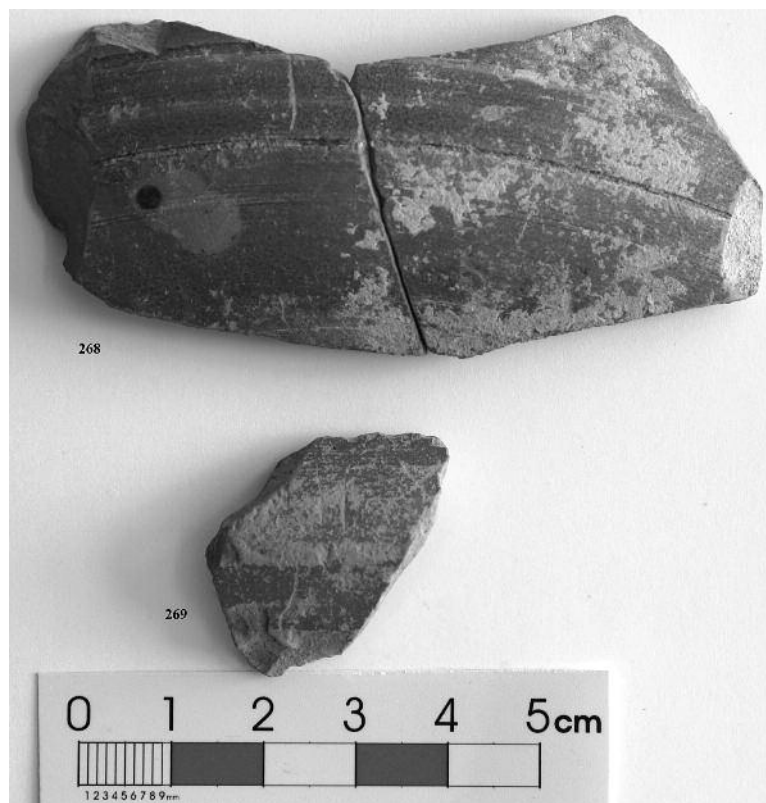

Pl. 46 :  
N<sup>os</sup> 268-269 – Local  
red-slipped ware,  
body fragments of  
open forms.



**Pl. 47 : N° 270 – Local red-slipped ware, fragment of a jug/small pot?**

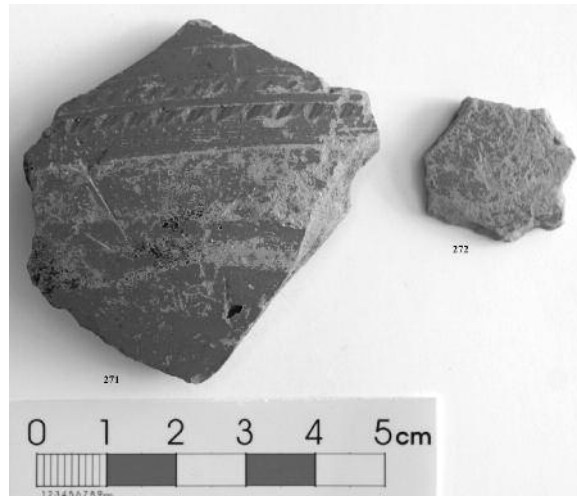

**Pl. 48 : N°s 271-272 – Local red-slipped ware, body fragments of closed forms.**



**Pl. 49 : N° 273 – Lamp fragment in red-slipped tradition.**